

# ROMAN SHADES

## Continuous Cord Loop

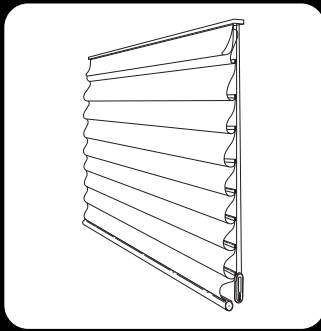

**3DAYBLINDS®**  
YOU'LL LOVE THE TREATMENT

### GETTING STARTED

A few simple tools are required:



Steel Tape Measure



Pencil

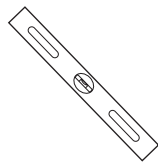

Level  
(for outside mount)



Power Drill and  
Drill Bits



Flathead & Phillips  
Screwdriver



Awl (or tool for  
starting a screw hole)

Included in your order is all the hardware necessary for a normal installation. Depending on the mounting surface, fasteners other than the screws provided may be required. Wall board and plaster require the use of anchors such as expansion or toggle bolts. Bricks, tile and stone need special plugs and drill bits. Wood should always be pre-drilled to avoid splitting.

Professional installation is also available in most areas, call 800-800-3329.

### STANDARD HARDWARE      OPTIONAL HARDWARE

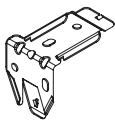

Standard  
Mounting Bracket

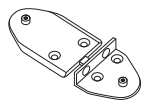

Tensioner Bracket  
with Screws

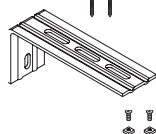

Extension Brackets  
with Nuts and Bolts

### OPTIONAL HARDWARE cont.

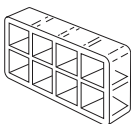

Spacers

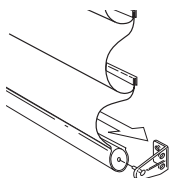

Hold Down Brackets  
with Screws



Valance Brackets



### BRACKET INFORMATION

The brackets you received with your product are REQUIRED for proper installation. Brackets should be installed at each end and any additional brackets will need to be evenly spaced between the two end brackets.

### INSIDE MOUNT

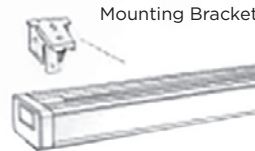

Mounting Bracket

- Note placement of components inside headrail. Brackets must be placed in the open area between components to avoid interfering with the operating mechanism. Mark these locations on top of window frame for inside mount or on wall for outside mount.

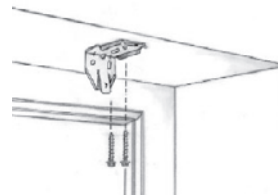

Inside Mount

- Mount brackets to top or back of window frame, 1" - 6" in from edge of frame. Make sure brackets are aligned with one another.



NOTE: If valance is ordered for Inside Mount Shade, attach the valance bracket on top of mounting bracket before drilling them both into the sill.

- Proceed to "Shade Installation".

## OUTSIDE MOUNT

NOTE: You will be using your shade with mounting brackets attached to the headrail to mark the position of the brackets on your wall or molding. DO NOT CUT the cellophane wrapping as the fabric or the cords supporting the shade may be inadvertently cut. Unwrap the cellophane and unwind the cords from around the headrail.

- Attach brackets to the headrail 3" from each end. Additional brackets, if included, are REQUIRED for proper installation and should be spaced evenly over the width of the headrail. Lower the shade to its full length. (See "Shade Operation".)

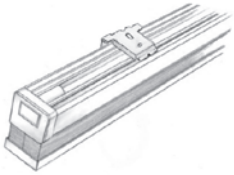

NOTE: If using extension brackets, attach mounting brackets to extension brackets with nuts and bolts before attaching brackets to headrail. (See "Optional Accessories")

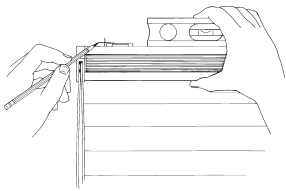

- Hold the shade up to the desired mounting position over the window. Once the shade is level, mark the wall or molding on either side and top edge of each mounting bracket.

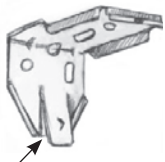

Locking tab

- Using your fingers or a screwdriver, press tab on back of each bracket to release the shade.

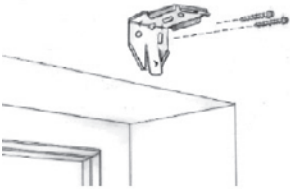

- Center shade over window opening at desired height. Mark the position of the headrail ends on the wall. Attach mounting brackets to the wall, 1" - 6" in from the marks, making sure brackets are aligned with one another.



NOTE: If ordered with valance, install valance bracket right next to the installation bracket just a little higher so valance slides in above headrail.

- Proceed to "Shade Installation".

## END MOUNT

An end mount is recommended for shades being installed with an arch top or for inside mount applications where there is no alternative mounting surface.

NOTE: You will be using your shade with mounting brackets attached to the headrail to mark the position of the brackets in your window opening. DO NOT CUT the cellophane wrapping as the fabric or cords supporting the shade may be inadvertently cut. Unwrap the cellophane and unwind the cords from around the headrail.

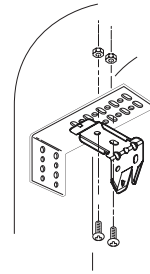

- Attach the mounting brackets to each extension bracket using the holes indicated in the diagram. Attach brackets to the headrail 1 1/2" from wall. Lower the shade to its full length. (See "Shade Operation".)

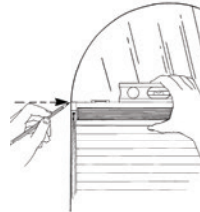

- With the mounting brackets attached, hold the shade up to the desired mounting position inside the window casing.

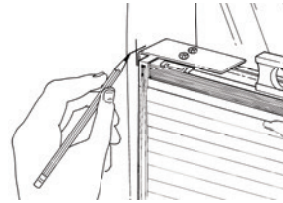

- Once the shade is level, recess the shade 1/4" from the front edge of the window casing and mark the wall on the front side and top edge of each extension bracket.



Locking tab

- Using your fingers or a screwdriver, press tab on back of each bracket to release the shade.

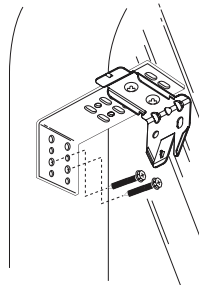

- Install an assembled end mounting bracket at each set of marks in your window opening.

## SHADE INSTALLATION

First, lower the middle and bottom rail about an inch. This will help keep the fabric from getting caught between the brackets and the headrail.

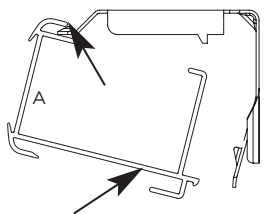

Push here upwards and towards the window

- Position the headrail with the front lip (A) resting on the top hooks of all the brackets. Make sure that no fabric is pinched between the brackets and the headrail.

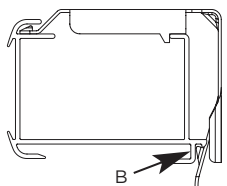

- Push the bottom of the headrail firmly upwards and towards the window until the groove at the bottom of the headrail snaps into place, (B) as shown.

## SHADE OPERATION

- To raise the shade, pull on the side of the cord loop.
- To lower the shade, pull on the other side of the cord loop. After lowering the shade all the way, the shade will begin to raise if you continue to pull the cord in the same direction..

## TENSIONER INSTALLATION

After installing the window covering, the Cord Tensioner must be mounted for the window covering to operate correctly. When properly installed, the Cord Tensioner functions as a safety device that makes the pull cord less accessible to children.

NOTE: If the mounting screws will not be secured into a wood stud, use wall anchors. For metal surfaces, pre-drill the holes and use sheet metal screws.

### IMPORTANT!

- Install the Cord Tensioner in a location that minimizes accessibility to children and pets and where it will not interfere with its operation.
- Only supplied Cord Tensioners and hardware should be used.

## MOUNTING OPTIONS

### Option A - Inside mount without a bracket

Cord Tensioner used in an inside mount application without a mounting bracket.

- Locate the Cord Tensioner as close to the window as possible to minimize accessibility by children and pets. Be sure the Cord Tensioner is not placed in the path of the window covering when raising and lowering.

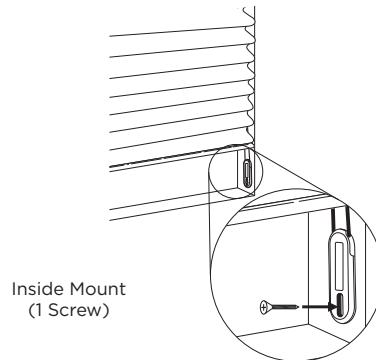

### Option B - Inside mount with a bracket

Cord Tensioner using the mounting bracket in an inside mount application.

- Locate the Cord Tensioner as close to the window as possible to minimize accessibility by children and pets. Be sure the Cord Tensioner is not placed in the path of the window covering when raising and lowering.

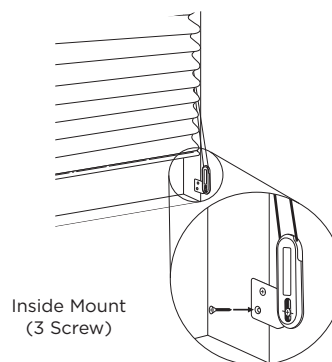

### Option C - Outside mount

Cord Tensioner using the mounting brackets in an outside mount application.

- Locate the Cord Tensioner as close to the window as possible to minimize accessibility by children and pets. Be sure the Cord Tensioner is not placed in the path of the window covering when raising and lowering.

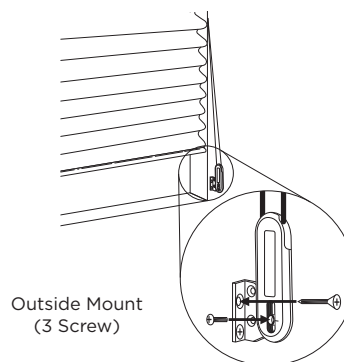

## MOUNTING

### Option A - Inside mount without a bracket

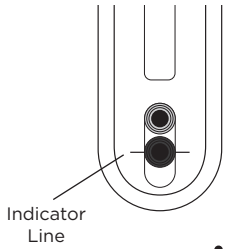

- To release the lock and engage the spring, use an awl, punch or small tip screwdriver to pull down the screw hole, so its center aligns with the indicator line on the Cord Tensioner.

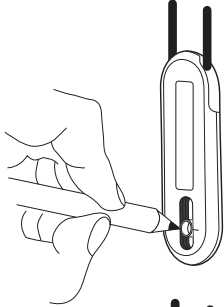

- Mark this location on the wall.

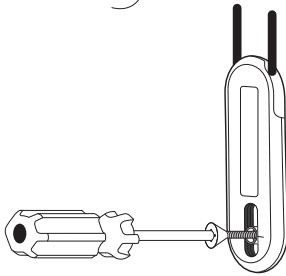

- Pre-Drill the holes for screws and anchors. For applications requiring anchors, use a  $7/32$ " frill bit. For applications not requiring anchors, use a  $3/32$ " drill bit and drill  $1\ 1/4$ " deep. If using anchors, tap them into the holes.

- Use a Phillips screwdriver and one of the longer screws provided to attach the Cord Tensioner directly to the wall.

### Option B or C

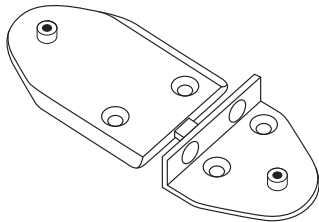

- Break off the bracket needed.

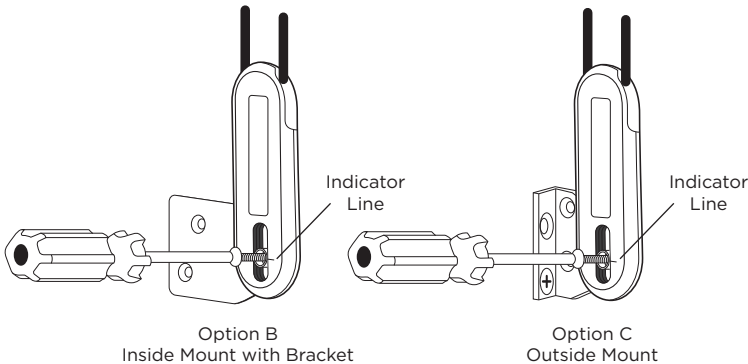

- Attach the bracket to the mounting bracket to the Cord Tensioner. The screw hole in the Cord Tensioner fits into the nub on the bracket.

- Release the lock and engage the spring by pulling the bracket downward so the center of the screw hole aligns with the indicator line on the Cord Tensioner. Mark the mounting bracket screw locations.

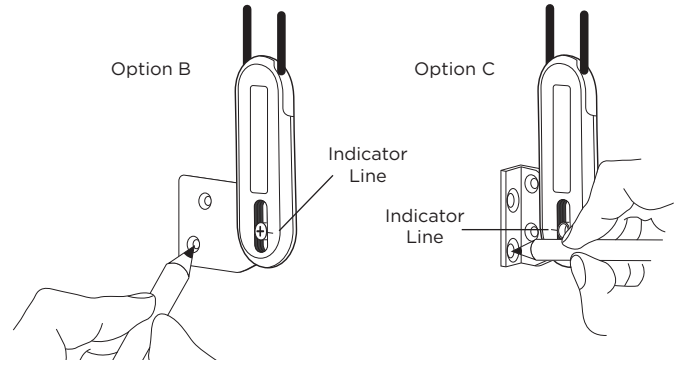

NOTE: Hold the mounting bracket firmly in place and check that the cord can move freely through the Cord Tensioner. If it cannot, the cord is too tight and the mounting bracket should move up. If the cord locks within the Cord Tensioner, the cord is too loose and the mounting bracket should be moved down.

- Pre-Drill the holes for screws and anchors. For applications requiring anchors, use a  $7/32$ " frill bit. For applications not requiring anchors, use a  $3/32$ " drill bit and drill  $1\ 1/4$ " deep. If using anchors, tap them into the holes.

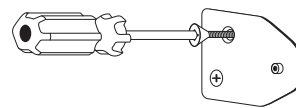

Option B

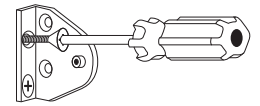

Option C

- Detach the Cord Tensioner from the mounting bracket by removing the small screw. Using a Phillips screwdriver and the two longer screws provided to mount the brackets to the wall.

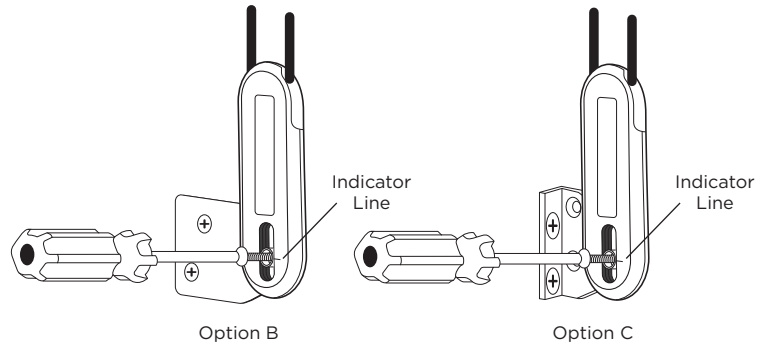

- Attach the bracket to the mounting bracket to the Cord Tensioner. The screw hole in the Cord Tensioner fits into the nub on the bracket.

## FINAL INSPECTION

Ensure the cord can move freely through the Cord Tensioner without engaging the lock. The center of the screw hole should be at least half way down the slot, aligned with the indicator line on the Cord Tensioner.

CAUTION: Do not put the screw hole all the way to the bottom of the slot as this may cause the cord to become too tight and increase cord wear.

# SHADE REMOVAL

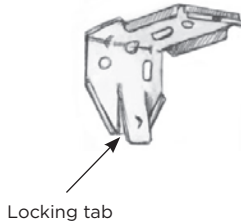

- Using your fingers or a screwdriver, press tab on back of each bracket to release the shade.

# OPTIONAL ACCESSORIES

## MOUNTING WITH EXTENSION BRACKETS

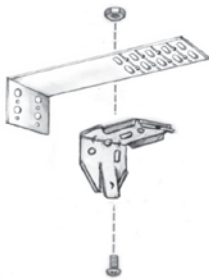

If you need to project the shade out from the mounting surface, use the supplied nuts and bolts to attach mounting brackets to the desired position in the extension bracket. With pliers, bend and break the unused part of the extension bracket. Attach extension brackets to mounting surface, making sure brackets are spaced as noted above

- Attach each mounting bracket to an extension bracket by using the nuts bolts and washers provided.
- Mount the extension bracket to the wall per the instructions for an "Outside Mount", using a level and making certain that all mounting brackets are level and project the same distance from the mounting surface. For maximum stability, install the screws diagonally from one another.
- Install the shade per the directions for "Shade Installation".

## SPACERS

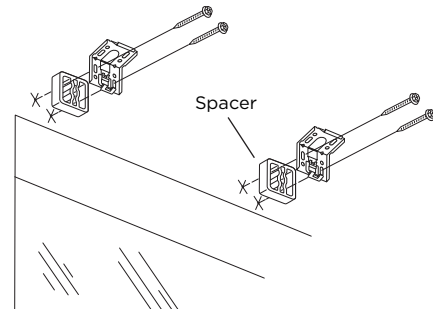

Spacers are available for use on windows with a projected molding. They are  $\frac{3}{8}$ " thick and allow the shade to be mounted flush with the outside edge of any standard window molding. They are available by contacting our Customer Care Department at 800-800-3329.

## HOLD DOWN BRACKETS

Hold down brackets are used primarily on shades mounted to doors or in motor homes. There are two small holes in the end caps that are covered by a thin plastic layer. Use the pin on the hold down bracket to push through the center of the end cap and it will break through the plastic layer.

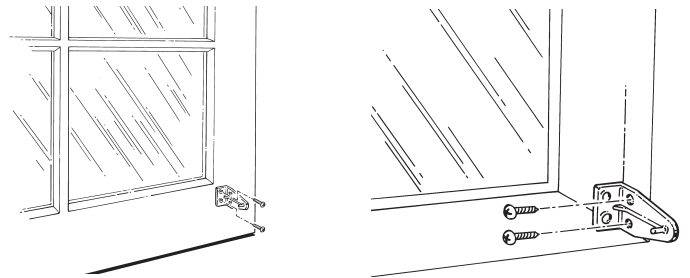

- With the shade lowered to its full length, place the pin of each hold down bracket into the hole in each end of the bottom rail
- Mark the mounting surface, either to the side or back of the window frame, through the holes in the hold down bracket. Make sure the hold down brackets are level and aligned with each other.
- Raise the shade and screw the hold down brackets into the mounting surface using the screws provided.

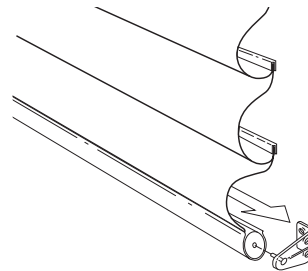

- Lower the shade and flex the hold down bracket outward so that the pin can be inserted into the hole in the end cap.



## WARNING

Young children can STRANGLE in cord and bead chain loops. They can also wrap cords around their necks and STRANGLE.

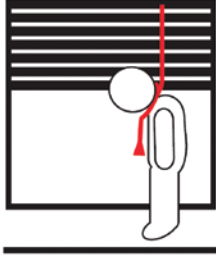

- Always keep cords and bead chains out of children's reach.
- Move cribs, playpens, and other furniture away from cords and bead chains. Children can climb furniture to get to cords.
- Attach tension device to wall or floor. This can prevent children from pulling cords and bead chains around their necks. Fasteners provided with the tension device may not be appropriate for all mounting surfaces. Use appropriate anchors for the mounting surface conditions.

ANSI/WCMA A100.1-2018 5.2.2



**3DAYBLINDS®**  
YOU'LL LOVE THE TREATMENT

800-800-3329 | [3dayblinds.com](http://3dayblinds.com)

Part # PM-054 © 3 Day Blinds LLC 06/20