

SIMPLY SHEER™

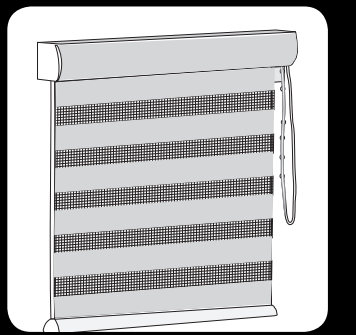

3DAYBLINDS™
YOU'LL LOVE THE TREATMENT

GETTING STARTED

A few simple tools are required:



Steel Tape Measure



Pencil

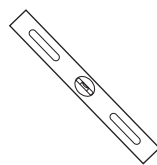

Level
(for outside mount)



Power Drill and
Drill Bits



Flathead & Phillips
Screwdriver



Awl (or tool for
starting a screw hole)

Included in your order is all the hardware necessary for a normal installation. Depending on the mounting surface, fasteners other than the screws provided may be required. Wall board and plaster require the use of anchors such as expansion or toggle bolts. Bricks, tile and stone need special plugs and drill bits. Wood should always be pre-drilled to avoid splitting.

Professional installation is also available in most areas, call 800-800-3329.

BRACKET INFORMATION

The brackets you received with your product are REQUIRED for proper installation. Brackets should be installed at each end and any additional brackets will need to be evenly spaced between the two end brackets.

STANDARD HARDWARE



Screws

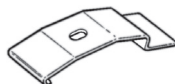

Inside Mount
Headrail Clip



Spacers



Bolt and Nut

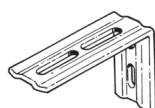

L-Bracket

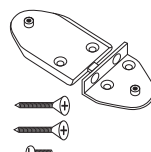

Tension Bracket
With Screws

INSIDE MOUNT

INSIDE MOUNT MOUNTING CLIP INSTALLATION

- Mounting clips must be positioned flat against the top of the window casing with the “tail” of the mounting clip positioned closest to the window.

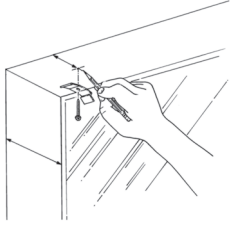

- All mounting clips must be placed minimum 1³/₄" from the front of the window casing.

- Using a drill and a 1/16" drill bit or an awl, make a small pilot hole at each pencil mark.
- Install the mounting clip using the screw provided and repeat the procedure each additional mounting clip.

OUTSIDE MOUNT

OUTSIDE MOUNT MOUNTING CLIP / BRACKET INSTALLATION

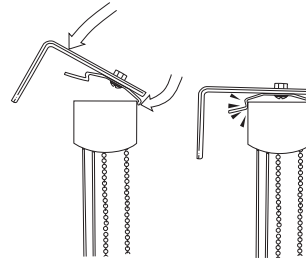

- Snap brackets on to the headrail

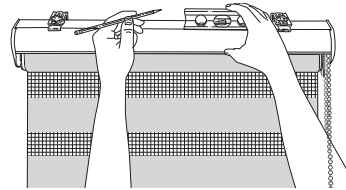

- Hold the headrail above the window opening so the bottom rail is positioned at the desired length.

- Once the shade is level, mark the wall above and to the side of each bracket using a pencil.

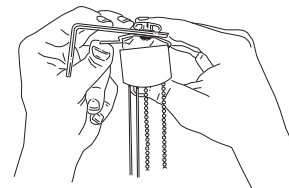

- Remove the brackets from the headrail by pushing up on the tail of each mounting clip. Set the headrail aside.

- Facing the window, position one bracket slightly under the left set of pencil marks.

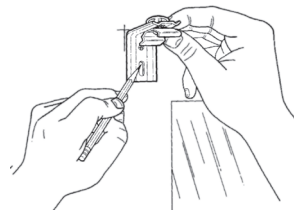

- Mark the screw holes on the mounting surface through the back of the bracket using a pencil.

- Using a drill with a 1/16" drill bit or an awl, make a small pilot hole at each pencil mark.

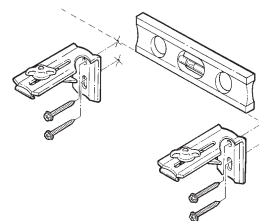

- Mount the bracket using two of the screws provided and repeat this procedure for any remaining brackets making sure all brackets are installed level and in line.

- Go to “Outside Mount Valance Installation”.

INSIDE MOUNT HEADRAIL INSTALLATION

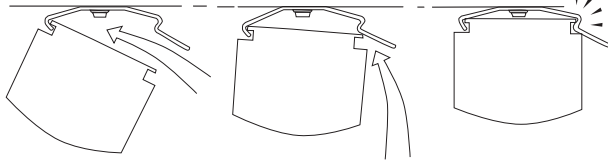

- Position the headrail so the blind controls are on the desired side of the window.
- Hook the front edge of the headrail into the front of the mounting clips (closest to you).
- Using a firm rolling motion while pressing up slightly on the tail of the mounting clips, rotate the headrail up and back until it snaps into the mounting clips.

TENSIONER INSTALLATION

After installing the window covering, the Chain Tensioner must be mounted for the window covering to operate correctly. When properly installed, the Chain Tensioner functions as a safety device that makes the pull chain less accessible to children.

NOTE: If the mounting screws will not be secured into a wood stud, use wall anchors. For metal surfaces, pre-drill the holes and use sheet metal screws.

IMPORTANT!

- Install the Chain Tensioner in a location that minimizes accessibility to children and pets and where it will not interfere with its operation.
- Only supplied Chain Tensioners and hardware should be used.

MOUNTING OPTIONS

Option A - Inside mount without a bracket

Chain Tensioner used in an inside mount application without a mounting bracket.

- Locate the Chain Tensioner as close to the window as possible to minimize accessibility by children and pets. Be sure the Chain Tensioner is not placed in the path of the window covering when raising and lowering.

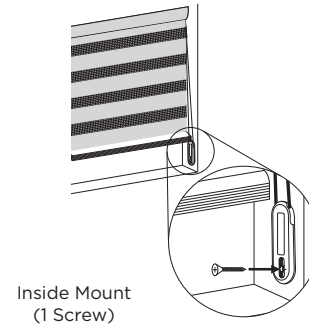

Inside Mount
(1 Screw)

Option B - Inside mount with a bracket

Cord Tensioner using the mounting bracket in an inside mount application.

- Locate the Chain Tensioner as close to the window as possible to minimize accessibility by children and pets. Be sure the Chain Tensioner is not placed in the path of the window covering when raising and lowering.

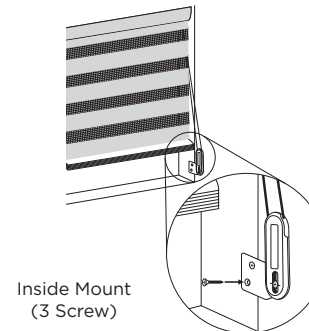

Inside Mount
(3 Screw)

Option C - Outside mount

Chain Tensioner using the mounting brackets in an outside mount application.

- Locate the Chain Tensioner as close to the window as possible to minimize accessibility by children and pets. Be sure the Chain Tensioner is not placed in the path of the window covering when raising and lowering.

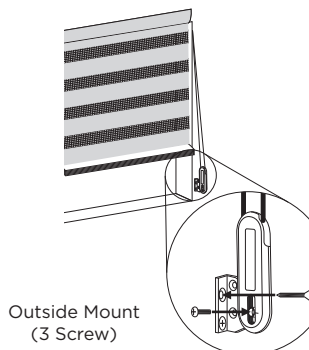

Outside Mount
(3 Screw)

MOUNTING

Option A - Inside mount without a bracket

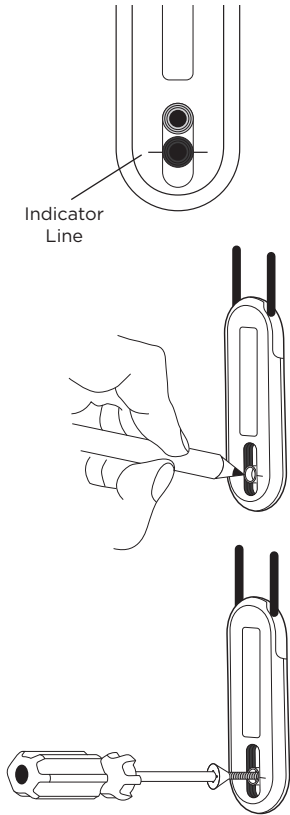

- To release the lock and engage the spring, use an awl, punch or small tip screwdriver to pull down the screw hole, so its center aligns with the indicator line on the Cord Tensioner.
- Mark this location on the wall.
- Pre-Drill the holes for screws and anchors. For applications requiring anchors, use a $\frac{7}{32}$ " frill bit. For applications not requiring anchors, use a $\frac{3}{32}$ " drill bit and drill $1\frac{1}{4}$ " deep. If using anchors, tap them into the holes.
- Use a Phillips screwdriver and one of the longer screws provided to attach the Chain Tensioner directly to the wall.

Option B or C

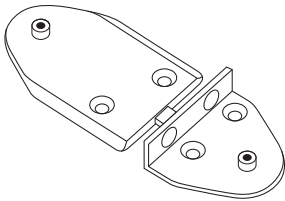

- Break off the bracket needed.

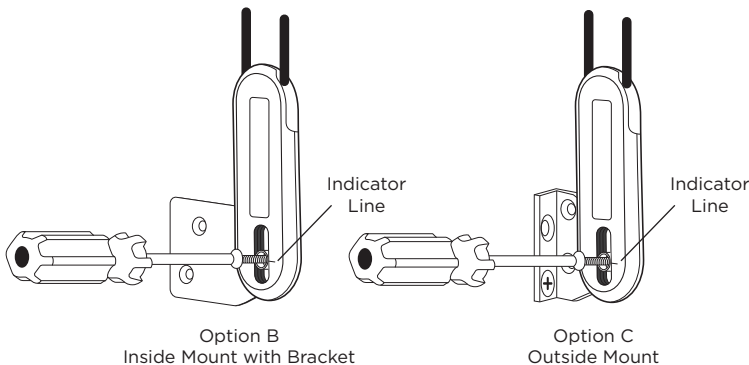

- Attach the bracket to the mounting bracket to the Chain Tensioner. The screw hole in the Chain Tensioner fits into the nub on the bracket.

- Release the lock and engage the spring by pulling the bracket downward so the center of the screw hole aligns with the indicator line on the Chain Tensioner. Mark the mounting bracket screw locations.

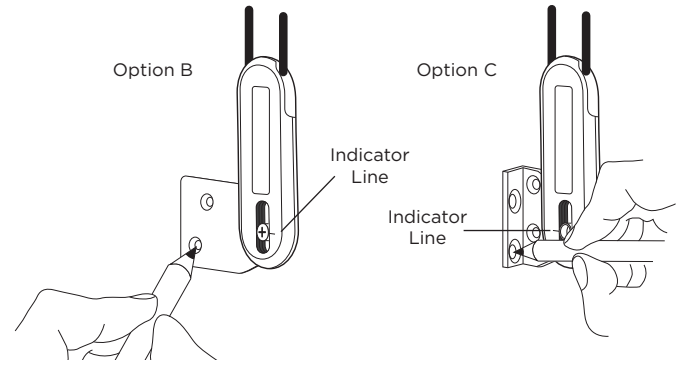

NOTE: Hold the mounting bracket firmly in place and check that the chain can move freely through the Chain Tensioner. If it cannot, the cord is too tight and the mounting bracket should move up. If the chain locks within the Chain Tensioner, the chain is too loose and the mounting bracket should be moved down.

- Pre-Drill the holes for screws and anchors. For applications requiring anchors, use a $\frac{7}{32}$ " frill bit. For applications not requiring anchors, use a $\frac{3}{32}$ " drill bit and drill $1\frac{1}{4}$ " deep. If using anchors, tap them into the holes.

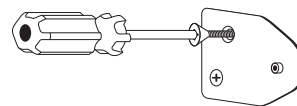

Option B

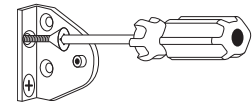

Option C

- Detach the Chain Tensioner from the mounting bracket by removing the small screw. Using a Phillips screwdriver and the two longer screws provided to mount the brackets to the wall.

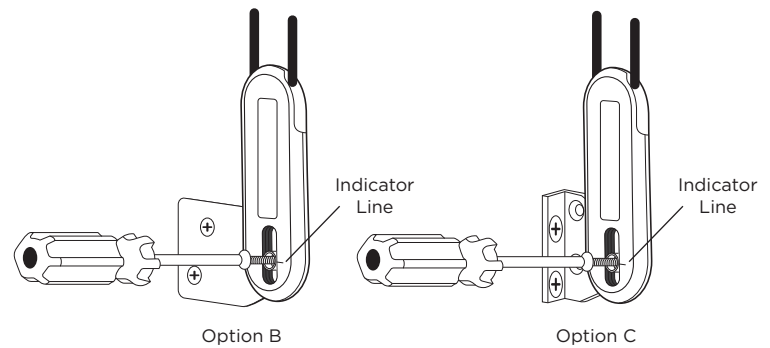

- Attach the bracket to the mounting bracket to the Chain Tensioner. The screw hole in the Chain Tensioner fits into the nub on the bracket.

FINAL INSPECTION

Ensure the chain can move freely through the Chain Tensioner without engaging the lock. The center of the screw hole should be at least half way down the slot, aligned with the indicator line on the Chain Tensioner.

CAUTION: Do not put the screw hole all the way to the bottom of the slot as this may cause the cord to become too tight and increase chain wear.

SHADE REMOVAL

- To remove the vanes, push the vane up to release the carrier clip and gently pull the vane toward you.

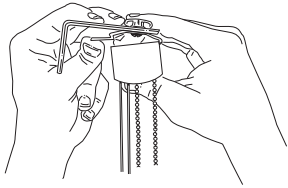

- To remove the headrail, push up on the tail of each mounting clip to release the headrail from the brackets.

HOW TO OPERATE THE SHADE

- To lower the shade, pull down wand on the back chain. Pull chain until shade reaches desired length. When lowering the shade the vanes will be in the open position. To close the vanes, pull the front chain down and the vanes will close.
- To raise the shade, pull the front chain and raise the shade to the desired position.



WARNING

Young children can strangle in in cord and bead chain loops. They can also wrap cords around their necks and STRANGLE.

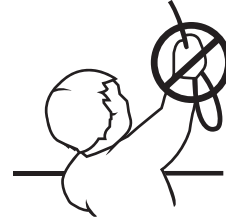

- Always keep cords and bead chains out of children's reach.
- Move cribs, playpens, and other furniture away from cords and bead chains. Children can climb furniture to get to cords.
- Attach tension device to wall or floor. This can prevent children from pulling cords and bead chains around their necks.



3 DAY BLINDS™

YOU'LL LOVE THE TREATMENT

800-800-3329 | 3dayblinds.com

Part #PM-018 © 3 Day Blinds Corporation 10/11