

FLEXCELL HONEYCOMB BLINDS

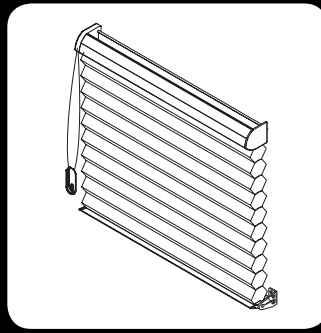

3DAYBLINDS®
YOU'LL LOVE THE TREATMENT

GETTING STARTED

A few simple tools are required:



Steel Tape Measure



Pencil

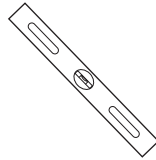

Level



Power Drill and
Drill Bits



Flathead & Phillips
Screwdriver



Awl (or tool for
starting a screw hole)

Included in your order is all the hardware necessary for a normal installation. Depending on the mounting surface, fasteners other than the screws provided may be required. Wall board and plaster require the use of anchors such as expansion or toggle bolts. Bricks, tile and stone need special plugs and drill bits. Wood should always be pre-drilled to avoid splitting.

Professional installation is also available in most areas, call 800-800-3329.

STANDARD HARDWARE

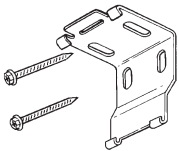

Mounting Bracket

OPTIONAL HARDWARE

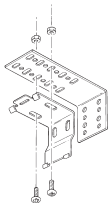

Extension Brackets
with Nuts and Bolts



Spacers

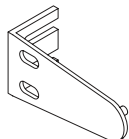

Hold Down Brackets

BRACKET INFORMATION

The brackets you received with your product are REQUIRED for proper installation. Brackets should be installed at each end and any additional brackets will need to be evenly spaced between the two end brackets.

BRACKET PLACEMENT

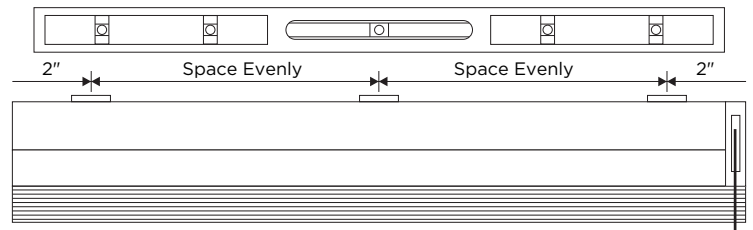

NOTE: Measure and mark all bracket locations before installing.

- Bracket placement is the same for inside and outside mounts.
- Measure 2" in from the ends of the headrail and mark the bracket location on the mounting surface.
- Space additional brackets evenly between the end brackets.
- Adjust the bracket placement to accommodate obstructions to the bottom rail, such as window cranks or handles.

INSIDE MOUNT

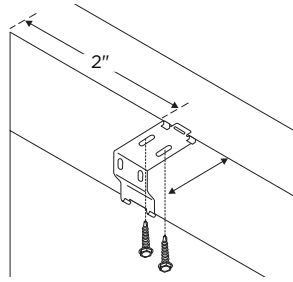

- Align the tops of each installation bracket to the top of the window opening and attach using two screws per bracket.
- Align the brackets to the inside of the mark on the mounting surface.
- Adjust the bracket placement to accommodate obstructions to the bottom rail, such as a window crank or handle.
- Use a carpenter's level to check that the brackets are level and aligned. Attach using two screws.
- Proceed to "Shade Installation".

OUTSIDE MOUNT

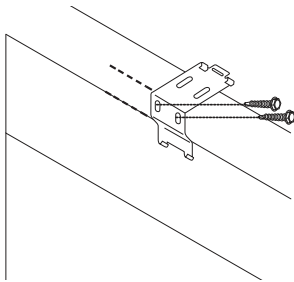

- Attach the back of each mounting bracket using two screws per bracket.
- Align the brackets to the inside of the mark on the mounting surface.
- Use a carpenter's level to check that the brackets are level and aligned.

- Proceed to "Shade Installation".

SIDE MOUNT

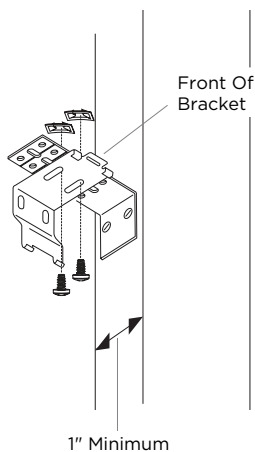

Side mount the headrail when conventional mounting techniques will not work, for example, in an arched window opening. The maximum width o

- Attach the mounting brackets to the underside of the extension brackets using the provided nuts and bolts.

BLIND INSTALLATION

NOTE: Do not remove the low tack protective tape from the face of the headrail until after the headrail is installed.

- With the colored side of the shade facing you, insert the headrail at an angle so the back tab on the bracket fits into the back groove on the headrail.

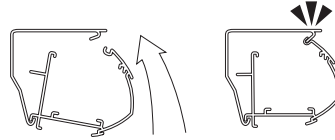

- Rotate the headrail up and back until it snaps into place.

BLIND OPERATION

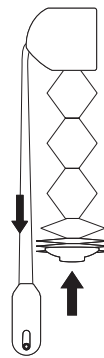

- To raise the shade, pull on the front of the cord loop.
- Pulling on the front of the cord loop at any time will also expand the vanes, blocking view through the shade.

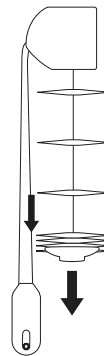

- To lower the shades, pull on the rear of the cord loop.
- Pulling on the rear of the cord loop at any time will also compress the vanes, permitting view through the shade.

Tip: If at any time the vanes do not open and close uniformly, "toggle" the cord loop by alternately pulling on the front and back cords in rapid succession.

TENSIONER INSTALLATION

After installing the window covering, the Cord Tensioner must be mounted for the window covering to operate correctly. When properly installed, the Cord Tensioner functions as a safety device that makes the pull cord less accessible to children.

NOTE: If the mounting screws will not be secured into a wood stud, use wall anchors. For metal surfaces, pre-drill the holes and use sheet metal screws.

IMPORTANT!

- Install the Cord Tensioner in a location that minimizes accessibility to children and pets and where it will not interfere with its operation.
- Only supplied Cord Tensioners and hardware should be used.

MOUNTING OPTIONS

Option A - Inside mount without a bracket

Cord Tensioner used in an inside mount application without a mounting bracket.

- Locate the Cord Tensioner as close to the window as possible to minimize accessibility by children and pets. Be sure the Cord Tensioner is not placed in the path of the window covering when raising and lowering.

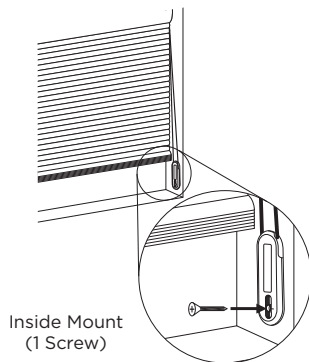

Option B - Inside mount with a bracket

Cord Tensioner using the mounting bracket in an inside mount application.

- Locate the Cord Tensioner as close to the window as possible to minimize accessibility by children and pets. Be sure the Cord Tensioner is not placed in the path of the window covering when raising and lowering.

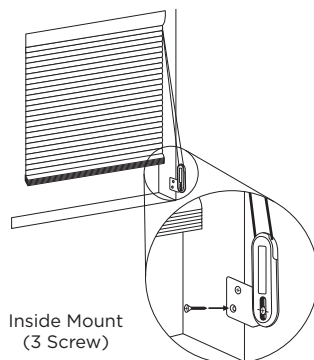

Option C - Outside mount

Cord Tensioner using the mounting brackets in an outside mount application.

- Locate the Cord Tensioner as close to the window as possible to minimize accessibility by children and pets. Be sure the Cord Tensioner is not placed in the path of the window covering when raising and lowering.

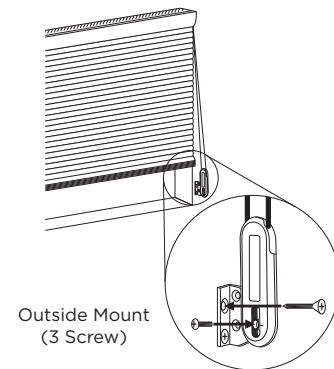

MOUNTING

Option A - Inside mount without a bracket

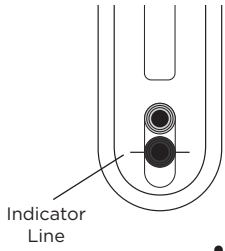

- To release the lock and engage the spring, use an awl, punch or small tip screwdriver to pull down the screw hole, so its center aligns with the indicator line on the Cord Tensioner.

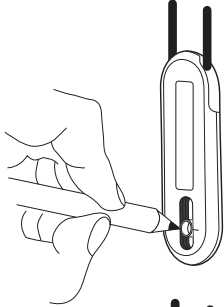

- Mark this location on the wall.

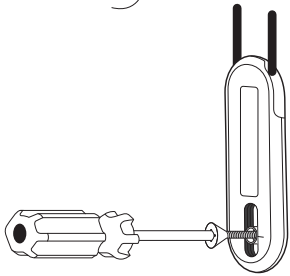

- Pre-Drill the holes for screws and anchors. For applications requiring anchors, use a $\frac{7}{32}$ " frill bit. For applications not requiring anchors, use a $\frac{3}{32}$ " drill bit and drill $1\frac{1}{4}$ " deep. If using anchors, tap them into the holes.

- Use a Phillips screwdriver and one of the longer screws provided to attach the Cord Tensioner directly to the wall.

Option B or C

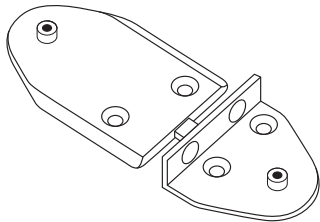

- Break off the bracket needed.

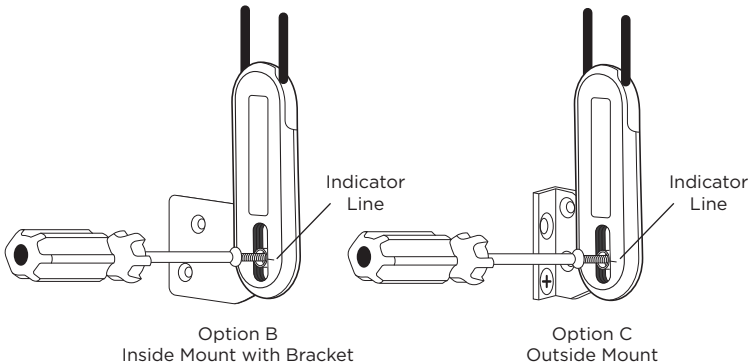

- Attach the bracket to the mounting bracket to the Cord Tensioner. The screw hole in the Cord Tensioner fits into the nub on the bracket.

- Release the lock and engage the spring by pulling the bracket downward so the center of the screw hole aligns with the indicator line on the Cord Tensioner. Mark the mounting bracket screw locations.

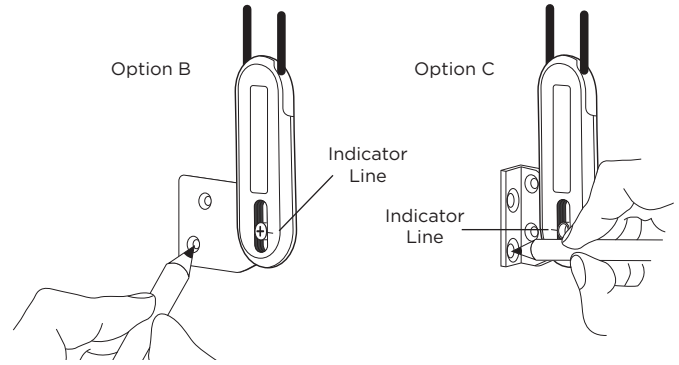

NOTE: Hold the mounting bracket firmly in place and check that the cord can move freely through the Cord Tensioner. If it cannot, the cord is too tight and the mounting bracket should move up. If the cord locks within the Cord Tensioner, the cord is too loose and the mounting bracket should be moved down.

- Pre-Drill the holes for screws and anchors. For applications requiring anchors, use a $\frac{7}{32}$ " frill bit. For applications not requiring anchors, use a $\frac{3}{32}$ " drill bit and drill $1\frac{1}{4}$ " deep. If using anchors, tap them into the holes.

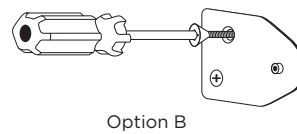

Option B

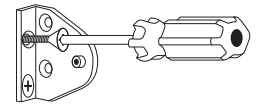

Option C

- Detach the Cord Tensioner from the mounting bracket by removing the small screw. Using a Phillips screwdriver and the two longer screws provided to mount the brackets to the wall.

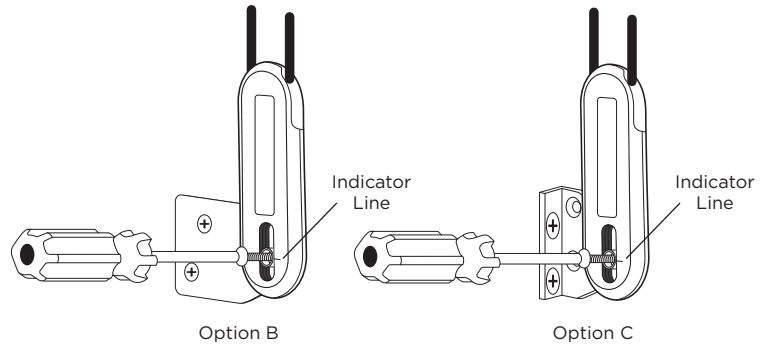

- Attach the bracket to the mounting bracket to the Cord Tensioner. The screw hole in the Cord Tensioner fits into the nub on the bracket.

FINAL INSPECTION

Ensure the cord can move freely through the Cord Tensioner without engaging the lock. The center of the screw hole should be at least half way down the slot, aligned with the indicator line on the Cord Tensioner.

CAUTION: Do not put the screw hole all the way to the bottom of the slot as this may cause the cord to become too tight and increase cord wear.

BLIND REMOVAL

- Using a cloth-covered, flat blade screwdriver, push up on the front tab of the mounting bracket to release the front of the headrail.
- Rotate the headrail downward and out from the bracket.

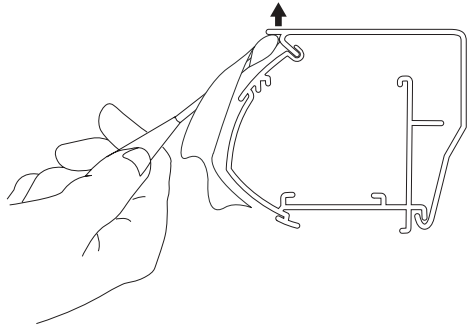

OPTIONAL ACCESSORIES

EXTENSION BRACKETS

Extension brackets project installation brackets up to 3" away from the mounting surface. This provides additional clearance for obstructions such as window cranks or handles.

To assemble and mount

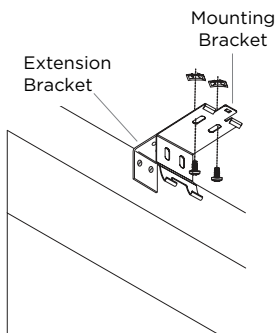

- Use a carpenter's level to check that the extension brackets are level and aligned. Attach using two screws.
- Attach the mounting brackets to the underside of the extension brackets using the provided nuts and bolts.

SPACER BLOCKS

Spacers are used on windows with a projected moulding. Each spacer block projects brackets $\frac{1}{2}$ " away from the mounting surface and allow the shade to be mounted flush with the outside edge of any stand and window moulding.

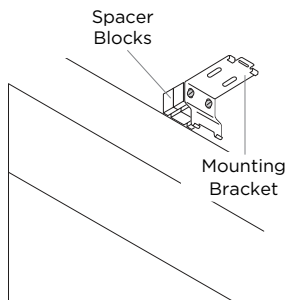

- Mount spacer blocks with the solid side facing the mounting surface.
- Use two mounting screws. Screws should be long enough to secure the bracket to the mounting surface.
- Use a maximum of three spacer blocks per bracket.

HOLD DOWN BRACKETS

Hold down brackets are used primarily on shades mounted to doors or in motor homes. There are two small holes in the end caps that are covered by a thin plastic layer. Use the pin on the hold down bracket to push through the center of the end cap and it will break through the plastic layer.

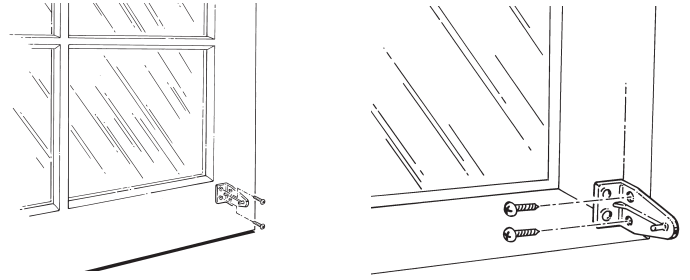

- With the shade lowered to its full length, place the pin of each hold down bracket into the hole in each end of the bottom rail.
- Mark the mounting surface, either to the side or back of the window frame, through the holes in the hold down bracket. Make sure the hold down brackets are level and aligned with each other.
- Raise the shade and screw the hold down brackets into the mounting surface using the screws provided.

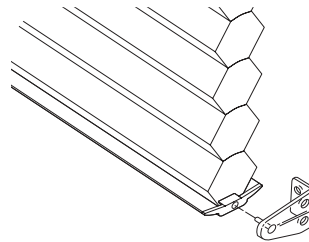

- Lower the shade and flex the hold down bracket outward so that the pin can be inserted into the hole in the end cap.

TROUBLE SHOOTING

PROBLEM: One or several vanes are pushed in (concaved).
SOLUTION: Use your hands to manually push the vane out.

PROBLEM: The lift cords appear loose or wavy.

SOLUTION: Operate the cord loop until any slack is taken up, and the cords appear taut. The 'wavy' lines should disappear.

PROBLEM: The shade is fully lowered, but the vanes seem to hang unevenly.

SOLUTION: If the vanes do not open and close uniformly, "toggle" the cord loop by alternately pulling on the front and back cords in rapid succession.



WARNING

Young children can STRANGLE in cord and bead chain loops. They can also wrap cords around their necks and STRANGLE.



- Always keep cords and bead chains out of children's reach.
- Move cribs, playpens, and other furniture away from cords and bead chains. Children can climb furniture to get to cords.
- Attach tension device to wall or floor. This can prevent children from pulling cords and bead chains around their necks. Fasteners provided with the tension device may not be appropriate for all mounting surfaces. Use appropriate anchors for the mounting surface conditions.

ANSI/WMCA A100.1-2012 5.2.4



3DAYBLINDS®
YOU'LL LOVE THE TREATMENT

800-800-3329 | 3dayblinds.com

Part # PM-010 © 3 Day Blinds Corporation 3/13