

ROLLER SHADES

Continuous Cord Loop & Link System without Cassette

Double Roller



3DAYBLINDS®
YOU'LL LOVE THE TREATMENT

GETTING STARTED

A few simple tools are required:



Steel Tape Measure



Pencil

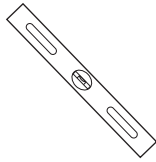

Level



Power Drill and
Drill Bits



Flathead & Phillips
Screwdriver



Awl (or tool for
starting a screw hole)

OPTIONAL HARDWARE

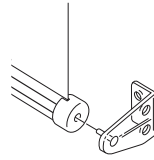

Hold Down Brackets

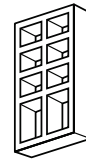

Spacer Block

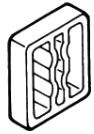

Spacers

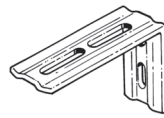

L-Bracket

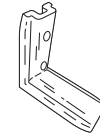

Plastic Corner

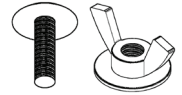

Wing Nut and Bolt

Included in your order is all the hardware necessary for a normal installation. Depending on the mounting surface, fasteners other than the screws provided may be required. Wall board and plaster require the use of anchors such as expansion or toggle bolts. Bricks, tile and stone need special plugs and drill bits. Wood should always be pre-drilled to avoid splitting.

Professional installation is also available in most areas, call 800-800-3329.

STANDARD HARDWARE

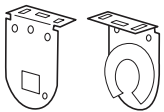

Mounting Brackets
with Screws

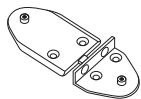

Tensioner Pulley
Anchors with Screws

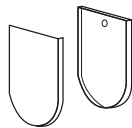

Bracket Covers
(Outside Mount Only)



Tension Pulley



Link System
Center Bracket

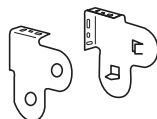

Double Roller
Mounting Brackets

INSIDE MOUNT

- Mount a bracket in each corner of the window. Make sure the appropriate bracket is used for the control side and idle side.

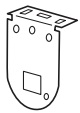
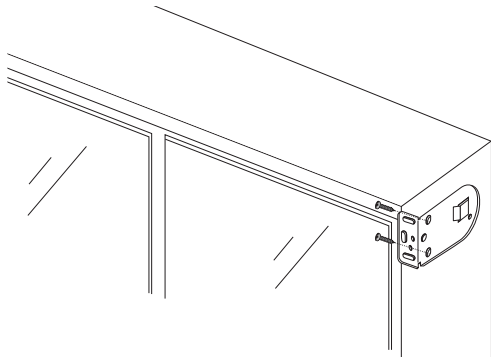

Control Side



Idle Side

- Proceed to "Shade Installation"

OUTSIDE MOUNT

- Mount brackets in desired location above window.

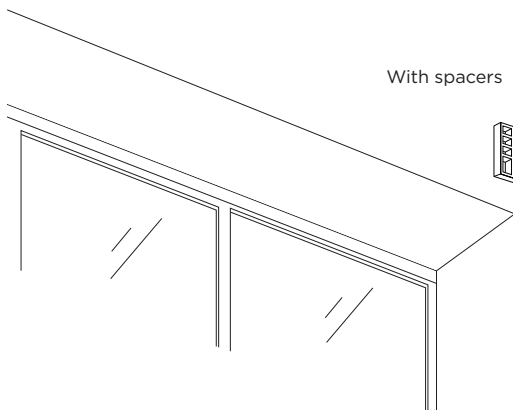
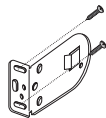
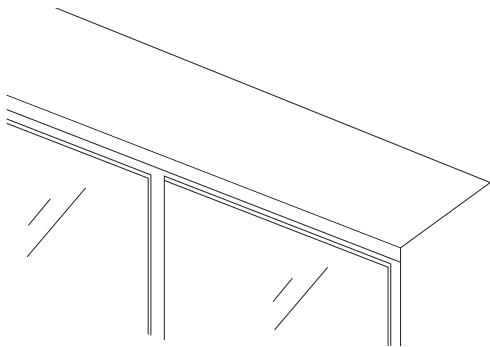

With spacers

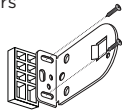

SHADE INSTALLATION

CONTINUOUS CORD LOOP WITHOUT CASSETTE

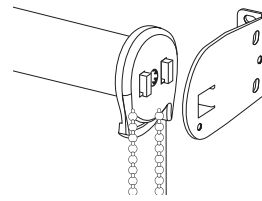

- Mount the control side first, making sure that the grooves on the clutch line up with the bracket. The logo on the clutch should be level.

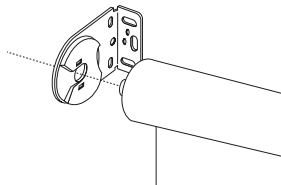

- Put the spring loaded pin end into the bracket. You should hear a snap. The idle is now in place.

- Once the idle side is snapped into place, gently pull down on the chain to make sure the shade is securely in the brackets.

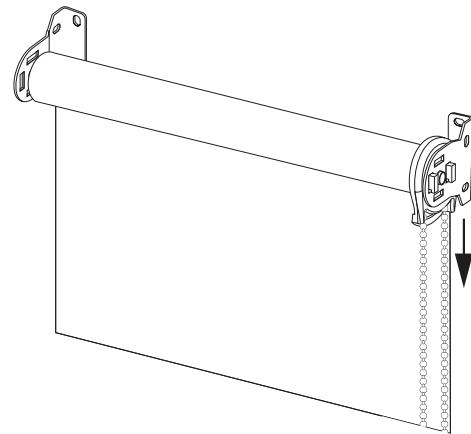

LINK SYSTEM

- Using a pencil, measure and mark the desired location above or inside the window frame for each bracket, making sure the appropriate bracket is used for the control side and idle side. Measure and mark where the center Link System bracket will be placed.
- Check that all brackets are level and in line with each other including the end mounting and Link System brackets.

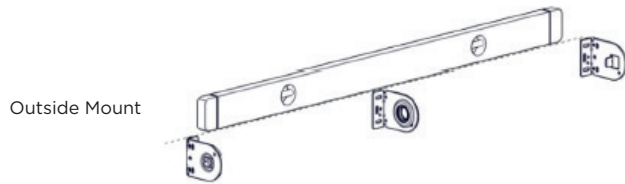
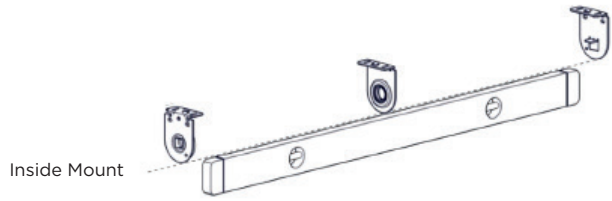

- Mount the bracket to the wall or window frame. Use the correct anchors or fasteners needed for your mounting surface.

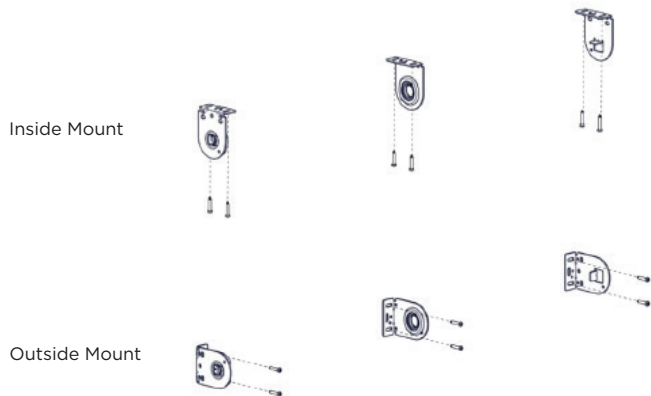

INSTALL THE CONTROL SIDE SHADE FIRST

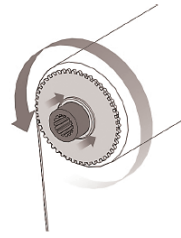

- Retract the idle side by rotating counter-clockwise.

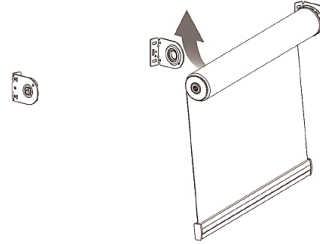

- Insert the control end of the shade into the bracket first, then swing the idle side into the center Link System bracket.

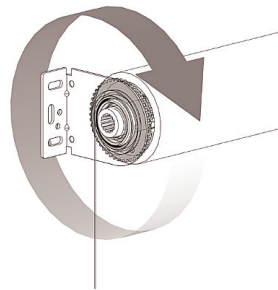

- Extend the idle side by rotating clockwise. Ensure the pin is fully extended through the center bracket.

- Repeat the previous steps to install the next shade.

- After the shades are installed, if the bottomrails do not line up with each other, they will need to be leveled. Rotate the male pin wheel counter-clockwise to retract the pin connection.

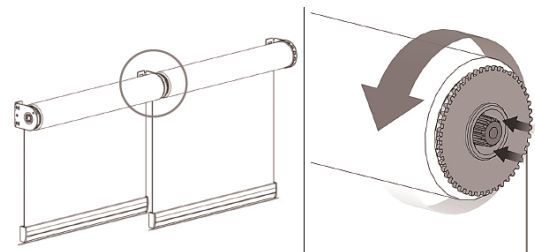

- Rotate the fabric roll until the bottomrails are in line and then extend the idle side back into the bracket by rotating clockwise.

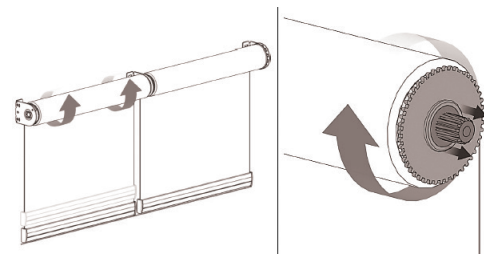

- Test the shade to ensure it is operating correctly and the panels are in sync.

DOUBLE ROLLER SHADES

- Mount a bracket in each corner of the window making sure the appropriate bracket is used for the control side and the idle side.

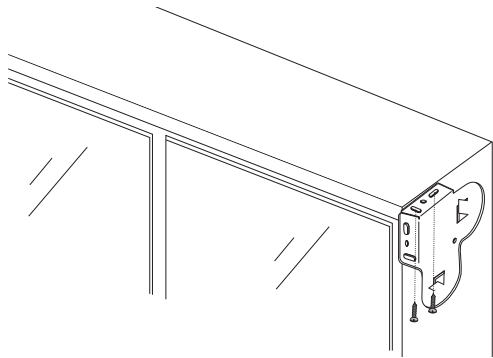

Idle Side

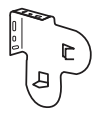

Control Side

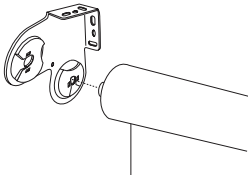
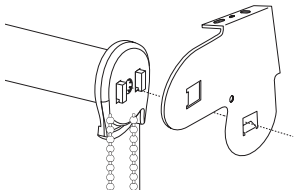

- Starting with the back roller shade, insert the control side first. Make sure the grooves on the clutch line up with the bracket. The logo on the clutch should be level.
- Place the spring loaded pin end into the opposite bracket. You should hear a snap. The idle side is now in place.
- The idle side can be adjusted for out of square windows by rotating the wheel clockwise on the side opposite the control.

- Repeat these steps for the front roller shade, keeping in mind the front shade is a reverse roll so the fabric will hang over the front of the roll.
- Once both shades are in place, gently pull down on the chains to make sure the shades are securely in the brackets.

OUTSIDE MOUNT BRACKET COVERS

CONTINUOUS CORD LOOP WITHOUT CASSETTE

Outside mount only.

- Bracket covers are slid over the bracket until snapped into position.

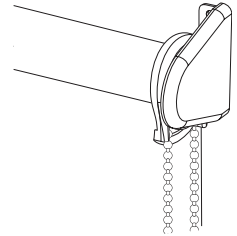
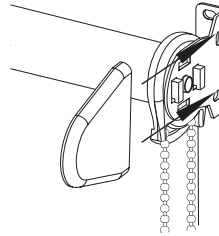

TENSIONER INSTALLATION

After installing the window covering, the Cord Tensioner must be mounted for the window covering to operate correctly. When properly installed, the Cord Tensioner functions as a safety device that makes the pull cord less accessible to children.

NOTE: If the mounting screws will not be secured into a wood stud, use wall anchors. For metal surfaces, pre-drill the holes and use sheet metal screws.

- For full tensioner installation instructions refer to the Installation manual in the hardware kit.

IMPORTANT!

- Install the Cord Tensioner in a location that minimizes accessibility to children and pets and where it will not interfere with its operation.
- Only supplied Cord Tensioners and hardware should be used.
- Release the lock and engage the spring by pulling the bracket downward so the center of the screw hole aligns with the indicator line on the Cord Tensioner. Mark the mounting bracket screw locations.

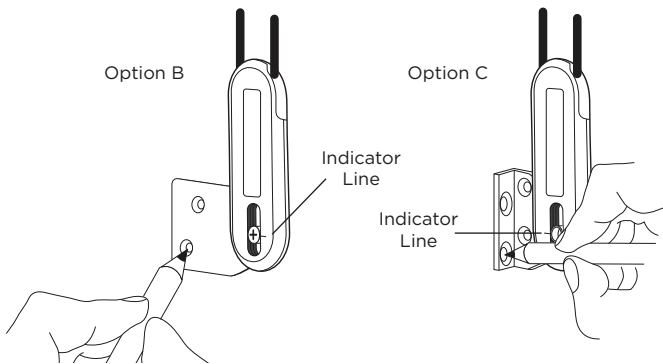

NOTE: Hold the mounting anchor firmly in place and check that the cord can move freely through the Cord Tensioner. If it cannot, the cord is too tight and the mounting anchor should move up. If the cord locks within the Cord Tensioner, the cord is too loose and the mounting anchor should be moved down.

- Pre-Drill the holes for screws and anchors. For applications requiring anchors, use a 7/32" drill bit. For applications not requiring anchors, use a 3/32" drill bit and drill 1 1/4" deep. If using anchors, tap them into the holes.

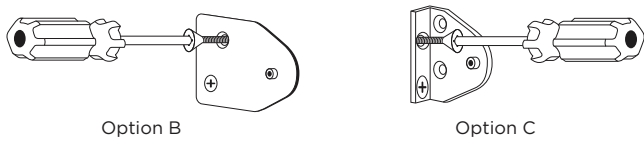

For Double Roller Shades

- Two Cord Tensioners will need to be mounted. If there is enough depth, both can be mounted inside the window frame.
- If there is not enough depth to properly mount both Cord Tensioners inside the window frame, the back Cord Tensioner will need to be inside mounted without an anchor (Option A) and the front Cord Tensioner will need to be Outside Mounted (Option C).

MOUNTING OPTIONS

Option A - Inside mount without an anchor

Cord Tensioner used in an inside mount application without an anchor.

- Locate the Cord Tensioner as close to the window as possible to minimize accessibility by children and pets. Be sure the Cord Tensioner is not placed in the path of the window covering when raising and lowering.

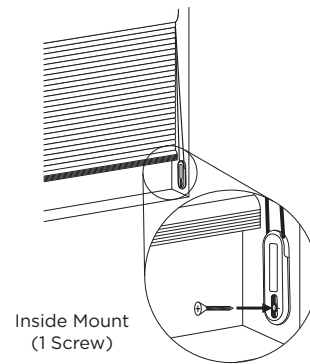

Option B - Inside mount with an anchor

Cord Tensioner using the mounting anchor in an inside mount application.

- Locate the Cord Tensioner as close to the window as possible to minimize accessibility by children and pets. Be sure the Cord Tensioner is not placed in the path of the window covering when raising and lowering.

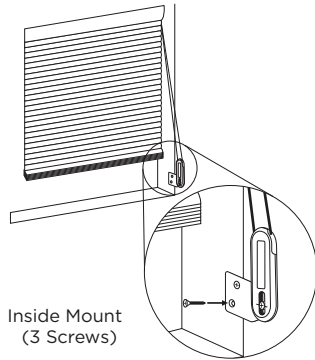

Option C - Outside mount

Cord Tensioner using the mounting anchor in an outside mount application.

- Locate the Cord Tensioner as close to the window as possible to minimize accessibility by children and pets. Be sure the Cord Tensioner is not placed in the path of the window covering when raising and lowering.

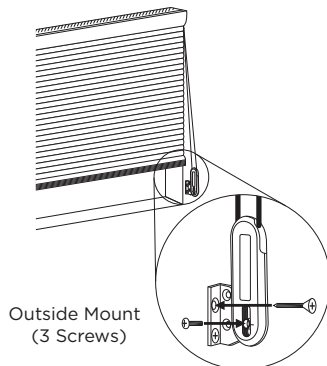

SHADE OPERATION

- To raise the shade, pull on outside portion of the cord loop chain.
- To lower the shade, pull on inside portion of the cord loop chain.

SHADE REMOVAL

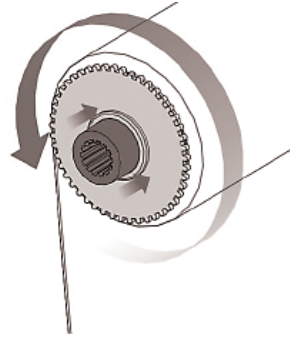

- To remove the shade, retract the idle side by rotating the clear plastic piece counter-clockwise. The pin should retract into the shade.
- Then pull the idle side out of the bracket first followed by the rest of the shade.

VALANCE ASSEMBLY

CORONADO AND MANHATTAN VALANCES

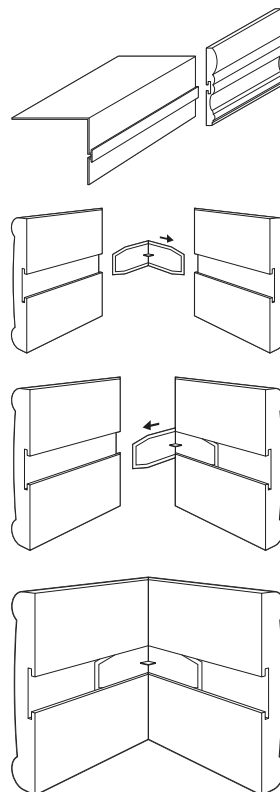

- Insert plastic corner into the valance and returns.
- If the valance returns are short, glue will be included instead of plastic corners. Apply a thin coat to the mitered end of both the valance and the returns.
- Join the ends of the valance returns with the valance by pressing the mitered edges together firmly for 60 seconds. Allow the glue to dry for at least 10 minutes before installing the valance.

VALANCE INSTALLATION

CORONADO AND MANHATTAN VALANCES (INSIDE MOUNT)

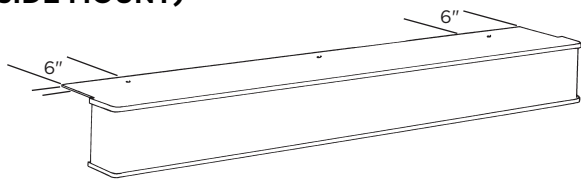

- To install, the valance must be pre-drilled. Using a pencil, mark pilot holes 6" in from each end of the valance and 3/4" in from the back of the valance. If additional brackets were sent with your valance mark additional pilot holes evenly spaced over the remaining width of the valance. Drill holes at the pencil marks using a 1/16" drill bit.

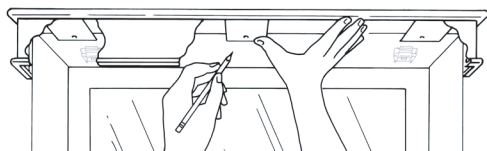

- Position the valance so that the plastic dust cover on the top of the valance fits inside of the window frame and the valance returns butt up against the wall on the outside of the window frame.
- Using the pencil, mark the window sill through the holes in the valance.

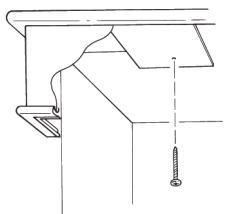

- Install valance using the screws provided.

CORONADO AND MANHATTAN VALANCES (OUTSIDE MOUNT)

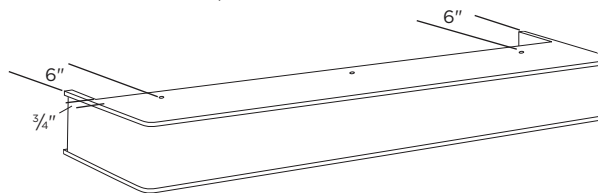

- To install, the valance must be pre-drilled. Using a pencil, mark pilot holes 6" in from each end of the valance and 3/4" in from the back of the valance. If additional brackets were sent with your valance mark additional pilot holes evenly spaced over the remaining width of the valance. Drill holes at the pencil marks using a 1/16" drill bit.

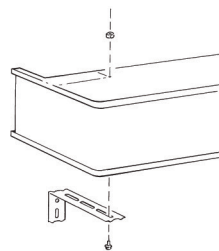

- Once the extension brackets are installed, position the valance over the window and roller shade.

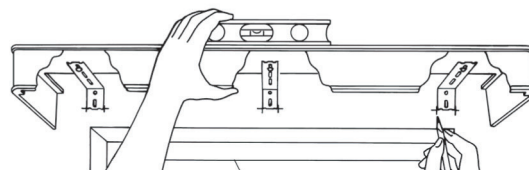

NOTE: The valance should be positioned to cover the top of the shade roll. Please leave enough room to allow the shade to operate properly. Using the level and a pencil, mark the bottom corners of each extension bracket.

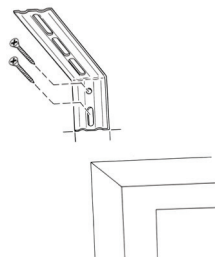

- Remove the extension brackets from the valance and install them using the screws provided.

OPTIONAL ACCESSORIES

HOLD DOWN BRACKETS

Hold down brackets are used primarily on shades mounted to doors or in motor homes. There are two small holes in the end caps. Use the pin on the hold down bracket to push through the hole in the end cap.

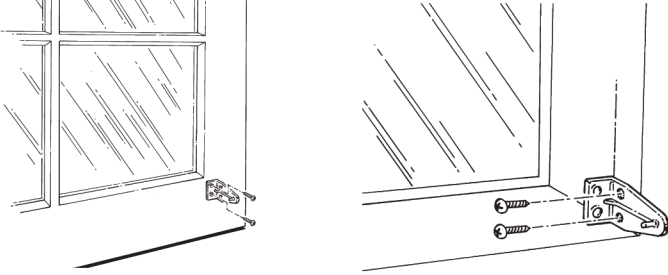

- With the shade lowered to its full length, place the pin of each hold down bracket into the hole in each end of the bottom rail.
- Mark the mounting surface, either to the side or back of the window frame, through the holes in the hold down bracket. Make sure the hold down brackets are level and aligned with each other.
- Raise the shade and screw the hold down brackets into the mounting surface using the screws provided.

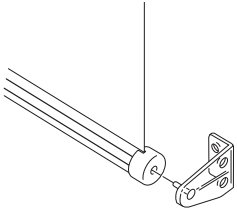

- Lower the shade and flex the hold down bracket outward so that the pin can be inserted into the hole in the end cap.

SPACER

Spacers are available for use on windows with a projected molding. They are $\frac{3}{8}$ " thick and allow the shade to be mounted flush with the outside edge of any standard window molding. They are available by contacting our Customer Care Department at 800-800-3329.

! WARNING ! ADVERTENCIA

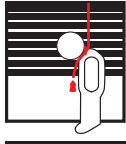

Window Blind Cord Strangulation Risk

Window Blinds with a damaged or loose tension device or retractable cord that fails to fully retract pose a strangulation risk to children. To avoid this potential strangulation risk, consider purchasing cordless products or products with inaccessible cords.

Riesgo de Estrangulamiento en Cuerdas de Persianas

Las persianas con un dispositivo tensor suelto o dañado o con una cuerda retractable que no se ajusta completamente representan un riesgo de estrangulación para los niños. Para evitar un posible riesgo de estrangulamiento, considere comprar productos inalámbricos o productos con cuerdas inaccessibles.

- Always keep cords and bead chains out of children's reach.
- Move cribs, playpens, and other furniture away from cords and bead chains. Children can climb furniture to get to cords.
- Attach tension device to wall or floor. This can prevent children from pulling cords and bead chains around their necks. Fasteners provided with the tension device may not be appropriate for all mounting surfaces. Use appropriate anchors for the mounting surface conditions.



3DAYBLINDS®
YOU'LL LOVE THE TREATMENT

800-800-3329 | 3dayblinds.com

Part # PM-049 © 3 Day Blinds LLC 5/24