



3DAYBLINDS®
YOU'LL LOVE THE TREATMENT



motorized[📶]
BY 3 DAY BLINDS

***Roman & TDBU Roman
Installation Instructions***

GETTING STARTED

A few simple tools are required:



Steel Tape Measure



Pencil



Level
(for outside mount)



Power Drill and
Drill Bits



Flathead & Phillips
Screwdriver



Awl (or tool for starting
a screw hole)

Included in your order is all the hardware necessary for a normal installation. Depending on the mounting surface, fasteners other than the screws provided may be required. Wall board and plaster require the use of anchors such as expansion or toggle bolts. Bricks, tile and stone need special plugs and drill bits. Wood should always be pre-drilled to avoid splitting.



- TDBU Roman Shade without Valance has internal battery.

STANDARD HARDWARE



Standard Mounting
Bracket



- External battery for Roman Shades.



- TDBU Roman Shade with Valance has internal battery.

OPTIONAL HARDWARE



Hold Down Brackets
and Screws



Spacers



Extension Bracket



Valance Bracket



NOTE: If valance is ordered for Inside Mount Shade, attach the valance bracket on top of mounting bracket before drilling them both into the sill.

BRACKET INFORMATION

The brackets you received with your product are **REQUIRED** for proper installation. Brackets should be installed at each end between end cap and the flat part of the cord spool. Any additional brackets will need to be evenly spaced between the two end brackets.

NOTE: Do not mount brackets over the flat part of the cord spools, improper placement of the brackets can result in poor operation of the shade.



- Using the Installation Bracket as a template measure to the edge of the bracket and mark the hole locations with a pencil for drilling. When mounting brackets make sure they are in line and level. Brackets must be in line and level. Shim brackets on inside mounts if necessary. The headrail must be level for the shade to operate properly.

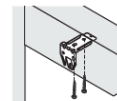

- Inside or Ceiling Mounts
Use the top bracket holes.

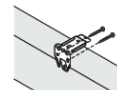

- Wall or Outside Mounts
Use the rear bracket holes.



- Be sure to mount the rechargeable battery wand before installing the brackets for the Roman shade. See next page for battery pack installation.
- 1 ¼" depth needed to install the battery pack. Make sure charging port is accessible to charge.

Charging Instructions

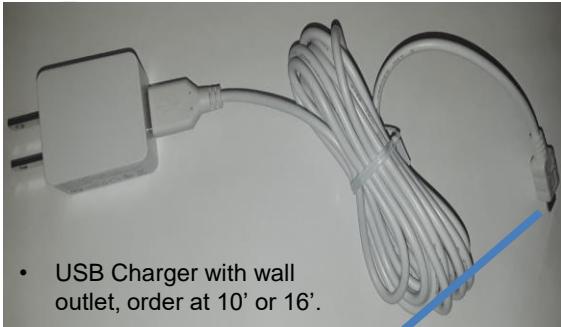

- USB Charger with wall outlet, order at 10' or 16'.



- Rechargeable Battery Pack w/clips

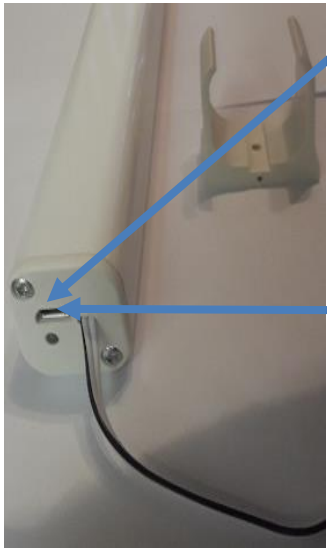

Charging Port for Roman Shades, where Micro USB plugs in.



Charging Port for TDBU Roman Shades, where Micro USB plugs in.

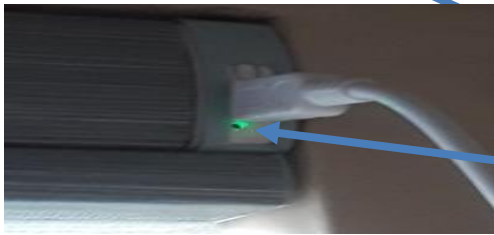

- Plug the charger into the wall and the micro USB tip into the battery wand charging port, similar to charging a cell phone.
- Charger can be left plugged in and will not harm the motor or battery. (They both have integrated overcharge protection circuits)
- Needs to be Charged about twice a year depending on usage.
- Production will charge the battery wand before sending it out to installer, it takes about 6 hours to fully charge.
- During operation, if the motor beeps 10 times, that is indicating a low battery and needs to be charged.
- During operation, if the battery is going low, it will stop running and will need to be charged.

Rechargeable Battery Status Indicator

- **Blinking Red** – Low Battery alert
- **Solid Red** - Charging
- **Blinking Green** – Charging in process
- **Solid Green** – Battery has finished charging

INSIDE MOUNT



- Note placement of components inside headrail. Brackets must be placed in the open area between components to avoid interfering with the operating mechanism. Mark these locations on top of window frame for inside mount or on wall for outside mount.

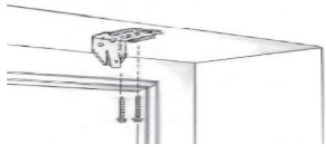

Inside Mount

- Mount brackets to top or back of window frame, 1" - 6" in from edge of frame. Make sure brackets are aligned with one another.

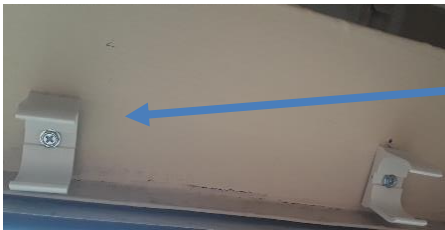

- First Install the battery wand clips 6" apart and back as far as you can in the sill if depth is less than 3 1/4". Remember to Install rechargeable battery pack on the side the motor will be on.



- Then snap the battery wand into the clips. Make sure the charging port is assessable.



- Install your first Honeycomb installation bracket up against the battery wand clip in sill depths 3 1/4" and less. Sill depths larger than 3 1/4" install front of bracket 1/4" recessed from front of sill, this will make the shade flush with sill. Then install battery pack behind the installation brackets.

WARNING: Pair remote to the Roman shade before installation, P1 button is in the motor, must remove end cap on shade and push button from side of headrail. TDBU Roman Shade can be paired to remote after installation.



- No external battery to install, proceed to programing instructions for operation.



- Connect the Power wire from the battery wand to the Power wire coming out of the shades motor. The shade should jog x1 letting you know there is power. If not jog happens you may have to charge the wand or check connection wires. You can now program the shade.

OUTSIDE MOUNT

NOTE: You will be using your shade with mounting brackets attached to the headrail to mark the position of the brackets on your wall or molding.

- Attach brackets to the headrail between the endcap and the flat part of the cord spool. Additional brackets, if included, are **REQUIRED** for proper installation and should be spaced evenly over the width of the headrail. Lower the shade to it's full length. (See "Shade Operation".)

NOTE: If using extension brackets, attach mounting brackets to extension brackets with nuts and bolts before attaching brackets to headrail. (See "Optional Accessories".)

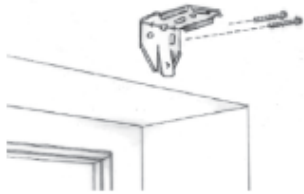

- Center shade over window opening at desired height. Mark the position of the headrail ends on the wall. Attach mounting brackets to the wall, 1" - 6" in from the marks, making sure brackets are aligned with one another.

- Install the battery pack 1/8" above the installation brackets on the motor side. Plug power wire from battery wand into power wire from the motor. The shade jog up & down indicating it has power. you do not get a jog, charge battery back.

- No external battery to install, proceed to programing instructions for operation.



END MOUNT

An end mount is recommended for shades being installed with an arch top or for inside mount applications where there is no alternative mounting surface.

NOTE: You will be using your shade with mounting brackets attached to the headrail to mark the position of the brackets in your window opening.

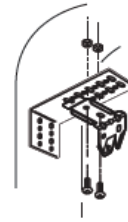

- Attach the mounting brackets to each extension bracket using the holes that are second to the last hole as shown in the diagram. Lower the shade to it's full length. (See "Shade Operation".)



- With the mounting brackets attached, hold the shade up to the desired mounting position inside the window casing.

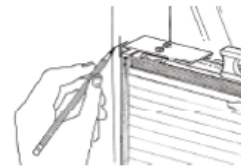

- Once the shade is level, recess the shade 1/4" from the front edge of the window casing and mark the wall on the front side and top edge of each extension bracket.

- Remove the mounting brackets from the headrail by pushing back and up on the "tail" of the bracket. See "Shade Removal".

- Install an assembled end mounting bracket at each set of marks in your window opening.

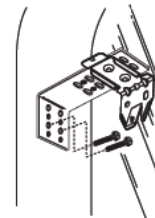

SHADE INSTALLATION

First, lower the middle and bottom rail about an inch. This will help keep the fabric from getting caught between the brackets and the headrail.

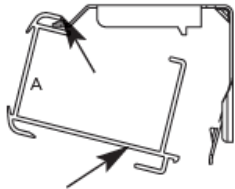

Push here upwards and towards the window

- Position the headrail with the front lip (A) resting on the top hooks of all the brackets. Make sure that no fabric is pinched between the brackets and the headrail.

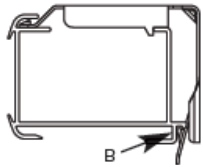

- Push the bottom of the headrail firmly upwards and towards the window until the groove at the bottom of the headrail snaps into place, (B) as shown.

SHADE REMOVAL

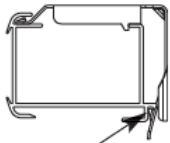

Insert screwdriver here and gently pry



- To remove a shade, insert a screwdriver between the headrail and the bottom back of the bracket (tab which extends out slightly from each bracket).
- Gently pry the screwdriver to release the bracket from the headrail. Take care not to damage the painted finish of the headrail.
- As you release the brackets, support the headrail to keep it from falling.

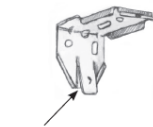

Locking tab

- Using your fingers or a screwdriver, press tab on back of each bracket to release the shade.

ADJUSTING THE SHADE (If Necessary)

- Raise and lower the shade several times.
- If the length is incorrect or the bottom rail is not level, use the following steps to correct.

BOTTOM RAIL SHADE ADJUSTMENT:

- Lift bottom rail on the side to be adjusted. This will take the weight off the cord.
- Use a screwdriver or dime.
 - Turn screw clockwise to lift that side of the shade
 - Turn screw counter clockwise to lower that side of the shade
 - Half a revolution is $\frac{1}{4}$ " adjustment (maximum adjustment is $\frac{1}{2}$ ")

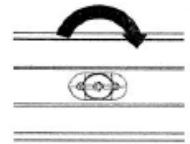

INTERMEDIATE RAIL SHADE ADJUSTMENT:

- Lift intermediate rail on side to be adjusted. This will take the weight off the cord.
- Use a screwdriver or dime.
 - Turn screw clockwise to lift that side of the rail
 - Turn screw counter clockwise to lower that side of the rail
 - Half a revolution is $\frac{1}{4}$ " adjustment (maximum adjustment is $\frac{1}{2}$ ")

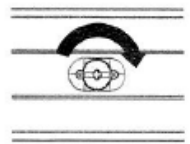

- Over-turning the adjustment screw (more than 1" of adjustment) can cause the cord to tangle or wedge inside the rail. The screw should turn easily - Do Not Force.

OPTIONAL ACCESSORIES

MOUNTING WITH EXTENSION BRACKETS

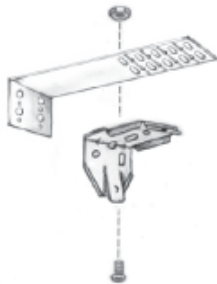

If you need to project the shade out from the mounting surface, use the supplied nuts and bolts to attach mounting brackets to the desired position in the extension bracket. With pliers, bend and break the unused part of the extension bracket. Attach extension brackets to mounting surface, making sure brackets are spaced as noted above

SPACERS

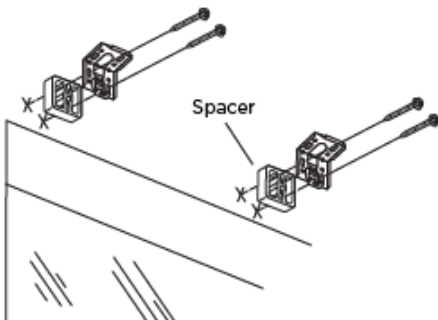

Spacers are available for use on windows with a projected molding. They are $\frac{3}{8}$ " thick and allow the shade to be mounted flush with the outside edge of any standard window molding. They are available by contacting our Customer Care Department at 800-800-3329.

HOLD DOWN BRACKETS

Hold down brackets are used primarily on shades mounted to doors or in motor homes. There are two small holes in the end caps that are covered by a thin plastic layer. Use the pin on the hold down bracket to push through the center of the end cap and it will break through the plastic layer.

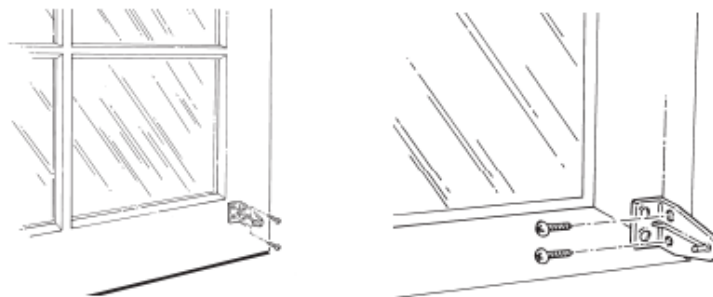

- With the shade lowered to its full length, place the pin of each hold down bracket into the hole in each end of the bottom rail.
- Mark the mounting surface, either to the side or back of the window frame, through the holes in the hold down bracket. Make sure the hold down brackets are level and aligned with each other.
- Raise the shade and screw the hold down brackets into the mounting surface using the screws provided.

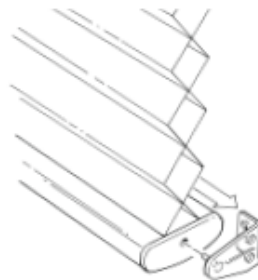

- Lower the shade and flex the hold down bracket outward so that the pin can be inserted into the hole in the end cap.

OPTIONAL ACCESSORIES

MOUNTING WITH EXTENSION BRACKETS

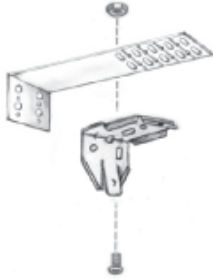

If you need to project the shade out from the mounting surface, use the supplied nuts and bolts to attach mounting brackets to the desired position in the extension bracket. With pliers, bend and break the unused part of the extension bracket. Attach extension brackets to mounting surface, making sure brackets are spaced as noted above

SPACERS

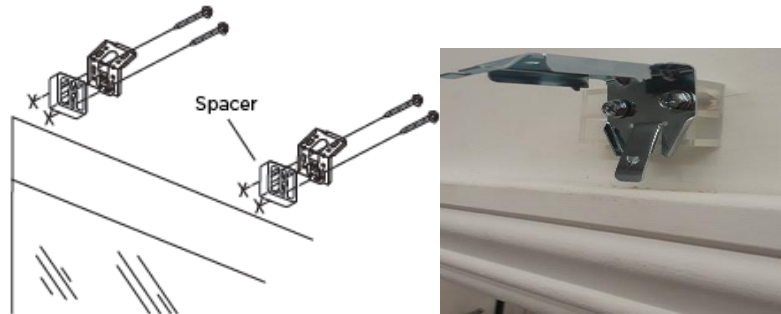

Spacers are available for use on windows with a projected molding. They are $\frac{3}{8}$ " thick and allow the shade to be mounted flush with the outside edge of any standard window molding. They are available by contacting our Customer Care Department at 800-800-3329.



WARNING

motorized[®]
by 3 DAY BLINDS

Young children can STRANGLE in cord and bead chain loops. They can also wrap cords around their necks and STRANGLE.

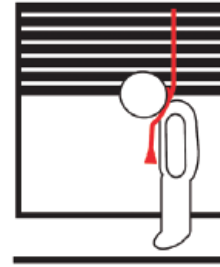

- Always keep cords and bead chains out of children's reach.
- Move cribs, playpens, and other furniture away from cords and bead chains. Children can climb furniture to get to cords.
- Attach tension device to wall or floor. This can prevent children from pulling cords and bead chains around their necks. Fasteners provided with the tension device may not be appropriate for all mounting surfaces. Use appropriate anchors for the mounting surface conditions.

SHADE OPERATION

- See Programming Guide Below.



3DAYBLINDS®
YOU'LL LOVE THE TREATMENT

motorized[📶]
BY 3 DAY BLINDS

Roman Shade Programming Guide

Specifications



- 0.6Nm DC motor for Cellular/Honeycomb shades
- Compatible with 3DB™ external battery pack
- Approximately 500 up/down cycles per each full charge
- 3 motor speed settings; 34, 40 or 50rpm
- Sound level ~48dB
- 5 year warranty

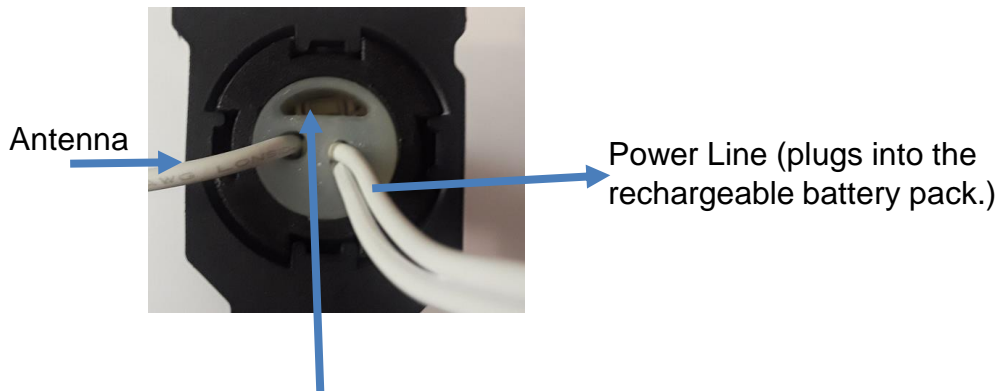

P1 button (Programming button on motor, **remember to program to the remote before installing the shade.** Use paper clip to reach button.)

Remote Button Instructions

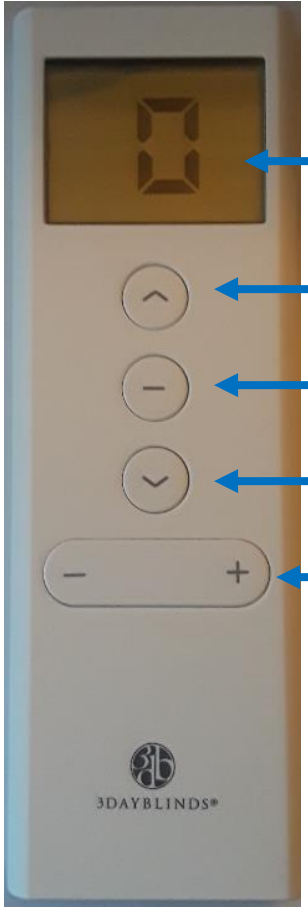

LCD Display (Channel you have selected, 0 operates all shades)

Up

Stop

Down

Channel Select
(15 Channel Remote, 0 is the all channel)



Small Blue Screw Driver – Used to secure back cover on remote. Also can be used to press the P1 button. LEAVE W/CLIENT

CR2450 Battery





Back cover

P2 Button (Remotes Program Button)

On / Off Switch (If shade does not respond to remote, check switch is On.)

P2 Button (Remotes Program Button)

P1 Programming Button Instructions (Remove end cap, Located at the end of the motor, follow steps before installing the shade)

- 1. Test Motor:** (Test to make sure shade is charged & used to operate shade manually without remote)
 - Press P1 (Less than 1 sec) Until Shade Jogs  x1
 - Shade will wake up and start running down, press P1 to stop shade, P1 again to raise the shade.
- 2. Pairing Mode:** (Used to pair the shade to a remote, first step before installing the shade)
 - Press P1 & Hold (Approx. 2 secs) Until shade Jogs  x1 then release.
 - When released the Motor will Beep x1, shade is ready to program to the remote
- 3. Sleep Mode:** (Used to program other shades on the same channel.)
 - Press P1 & Hold (Approx. 6 secs) Until Shade Jogs  x2
 - When released the Motor will Beep x2, press up or down on remote, shade should not move.
- 4. Reverse Direction:** (Used when shade goes up when you push down or down when you push up.)
 - Press P1 & Hold (Approx. 10 secs) Until Shade Jogs  x3
 - When released the Motor will Beep x3, press up or down on remote to check for proper direction is saved.
- 4. Reset To Factory Settings:** (Used to erase all previous programming and start with a clear motor.)
 - Press P1 & Hold (Approx. 10 secs) Until Shade Jogs  x4
 - When released the Motor will Beep x4 shade should not respond to remote, start from beginning with pairing the shade and setting the limits.

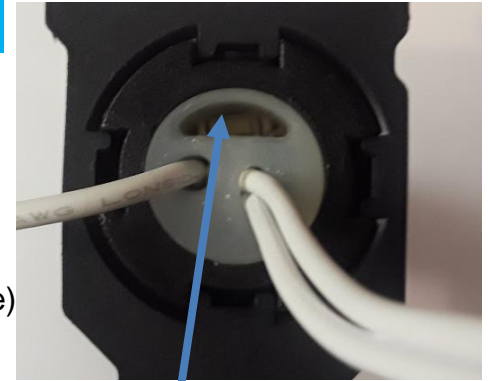

Remember to plug in the rechargeable battery wand and Pair the remote to shade before installing. P1 button (Remote will come with small blue screw driver that can be used to push the P1 button)

Pair / Unpair Remote Control To Shade

Step 1 : Press P1 button (about 2 sec) on the motor head until motor jog x1 and beep x1.

Step 2 : In the next 10 secs, press the + or – on the remote to select the channel you want the shade to be on, press and hold “Stop (-)” button until motor jog x2 and beep x3.

- Repeat the same procedure to unpair remote control and remove the shade from previous channel. Production has set the limits so shade should be ready to operate, see “Adjust Limits” to change the upper and lower limit.

Change Motor Direction (Only if Necessary)

Step 1 : Press “Up” or “Down” button to check if the shade moves in the desired direction.

- If you need to reverse the direction, press and hold (about 2 sec) “Up” and “Down” buttons simultaneously until motor jog x1 and beep x1.

*The operation is only valid when there are no limits. If the motor has already set the upper and lower limit, then you can only switch direction by pressing P1 button (See P1 button instructions).

Setting the Upper & Lower Limits (These Steps are done if no limits are set from Factory, or you have Reset the motor to Factory Settings)

Step 1 : Set Upper Limit

- a. Press “Up” button to raise the shade, then press “Stop” button when it is in the desired upper limit.
- b. Press and hold (about 5 sec) “Up” and “Stop” buttons simultaneously until motor jog x2 and beep x3.

Step 2 : Set Lower Limit

- a. Press “Down” button to lower the shade, then press “Stop” button when it is in the desired lower limit.
 - b. Press and hold (about 5 sec) “Down” and “Stop” buttons simultaneously until motor jog x2 and beep x3.
- If you exit the limit setting status before you finish the limit settings, the motor will take the previous existing limits.
 - After you are done setting the upper and lower limit the shade is ready to operate and is in user mode.

Adjust the Upper & Lower Limits (These Steps are done when in user mode & when limits are already set from factory)

Step 1 : Adjust the Upper Limit

- a. Press and hold (about 5 sec) “Up” and “Stop” buttons simultaneously until motor jog x1 and beep x1.
- b. Use “Up” button to raise the shade to the desired highest position, and use “Up” or “Down” button to do the final adjustment if necessary.
- c. Press and hold (about 5 sec) “Up” and “Stop” buttons simultaneously until motor jog x2 and beep x3.

Step 2 : Adjust the Lower Limit

- a. Press and hold (about 5 sec) “Down” and “Stop” buttons simultaneously until motor jog x1 and beep x1.
- b. Use “Down” button to lower the shade to the desired lowest position, and use “Up” or “Down” button to do the final adjustment if necessary.
- c. Press and hold (about 5 sec) “Down” and “Stop” buttons simultaneously until motor jog x2 and beep x3.

Favorite Position (By pressing & Hold “Stop” shade will go to this saved spot every time)

Action: Set Favorite Position

Step 1 : Use “Up” or “Down” button to move the shade to desired Favorite position.

Step 2 : Press and hold (about 2 sec) one “P2” button on the back of remote control until motor jog x1 and beep x1.

Step 3 : Press and hold (about 2 sec) “Stop” button until motor jog x1 and beep x1.

Step 4 : Once more, press and hold (about 2 sec) “Stop” button until motor jog x2 and beep x3.

Action : Send Shade to Favorite Position

Step 1 : Press and hold (about 2 sec) “Stop” button, motor will move to Favorite position.

Action : Delete Favorite Position

Step 1 : Press and hold (about 2 sec) one “P2” button until motor jog and beep x1.

Step 2 : Press and hold (about 2 sec) “Stop” button until motor jog and beep x1.

Step 3 : Once more, press and hold (about 2 sec) “Stop” button until motor jog x1 and long beep x1.

Roller Mode & Sheer Mode (Sheer Mode is used to operate Roller shades in short increments and in Horizontal Sheer its used to open the slats in increments adjusting light control better)

Action: Roller Shade Mode - continue movement after a short press - Default Mode

Step 1 : Press and hold (about 5 sec) “Up” and “Down” buttons simultaneously until motor jog x1.

Step 2 : Press and hold (about 2 sec) “Stop” button until motor jog x2 and beep x3.

Action : Sheer Shade Mode - jog movement after a short press (continue movement after a long press)

Step 1 : Press and hold (about 5 sec) “Up” and “Down” buttons simultaneously until motor jog x1.

Step 2 : Press and hold (about 2 sec) “Stop” button until motor jog x1 and beep x1.

Add or Remove Additional Remote

Step 1 : On the current remote control, press and hold (about 2 sec) one “P2” button until motor jog x1 and beep x1.

Step 2 : Once more, on the current remote control, press and hold (about 2 sec) one “P2” button until motor jog x1 and beep x1.

Step 3 : On the New remote control, press and hold (about 2 sec) one “P2” button until motor jog x2 and beep x3.

* Repeat the same procedure to remove additional remote control.

Grouping Shades (Used to have a group of shades on one channel to operate simultaneously.)

Step 1 : On the remote Select the channel you want to add to a group. Turn remote over and remove battery cover.

Step 2 : Press and release (less than 1 sec) one of the “P2” buttons, shade will jog x1 and beep x1.

Step 3 : Press and release (less than 1 sec) one of the “P2” buttons again, shade will jog x1 and beep x1.

Step 4 : Turn the remote back over and select the channel you want to add the shade to (the group channel).

Step 5 : Turn remote over, Press and release (less than 1 sec) one of the “P2” buttons, shade will jog x2 and beep x3. Shade will now work on both original channel and the group channel.

* Repeat the same procedure to remove the shade from the group channel.

* You can also add the shade to a group channel by using the P1 button. Press the P1 button on the motor head(Approx. 2 sec) shade will jog x1 and Beep x1. Then select the channel you want to add the shade to and press & hold the Stop button until the shade jog x2 and beep x3. Its now added to the group shades as well as its original channel. Repeat steps to erase shade from group.

Adjust Motor Speed (Used if all shades are running at different speeds, increasing the speed will shorten battery life.)

Action : Acceleration Speed

Step 1 : Press one “P2” button until motor jog x1 and beep x1.

Step 2 : Press “Up” button until motor jog x1 and beep x1.

Step 3 : Once more, press “Up” button until motor jog x2 and beep x1.

Action : Deceleration Speed

Step 1 : Press one “P2” button until motor jog x1 and beep x1.

Step 2 : Press “Down” button until motor jog x1 and beep x1.

Step 3 : Once more, press “Down” button until motor jog x2 and beep x1.

* If the motor has no response, it already has a Maximum or Minimum speed.

Advanced Setting (Disable Limit Setting so they are not changed by mistake)

Step 1 : Remove the cover from the backside of remote, the lock switch is in the right corner.

Step 2 : Move the switch to the “Lock” position to disable the following commands, remote will show “L” (lock):

- Change Motor Direction
- Setting the Upper and Lower Limit
- Adjust Limit
- Roller Mode or Sheer Mode

Step 3 : Move the switch to “Unlock” position to assess all remote functions, remote will show “U” (unlock).

* This advanced feature is intended to be used after all shade programming is completed. User Mode will prevent accidental or unintended changing of limits.

Quick Index

Settings	Steps
1 Pairing	P1 (hold down for 2s) > Stop (hold down for 2s)
2 Switch Rotating Direction	Up + Down (hold down for 2s)
3 Setting Upper & Lower Limits	Upper Limit: Up (hold down for 2s) > Up + Stop (hold down for 2s) Lower Limit: Down (hold down for 2s) > Down + Stop (hold down for 2s)
4 Add / Remove Favorite Position	P2 > Stop > Stop
5 Roller Mode & Sheer Mode Switch	Up + Down (hold down for 5s) > Stop
6 Adjust Limits	Upper Limit: Up + Stop (hold down for 5s) > Up or Down > Up + Stop (hold down for 2s) Lower Limit: Down + Stop (hold down for 5s) > Up or Down > Down + Stop (hold down for 2s)
7 Pair / Unpair Additional Emitter	P2 (existing) > P2 (existing) > P2 (new)
8 Speed Regulation	Acceleration: P2 > Up > Up Deceleration: P2 > Down > Down

Troubleshooting

Issues	Possible Causes	Solution
The motor has no response	Battery in motor is depleted	Recharge with compatible AC adaptor and check connection and positioning of solar PV panel
	Insufficient charging from Solar PV Panel	Check connection and orientation of solar PV panel
	Remote control battery is discharged	Replace battery
	Battery is inserted incorrectly into remote control	Check battery polarity
	Radio interference / shielding	Ensure remote control and the antenna on the motor are positioned away from metal objects
	Receiver distance is too far from Remote Control	Move remote control to a closer position
	Power failure	Check power supply to motor is connected and active
	Incorrect wiring	Check that wiring is connected correctly (refer to motor installation instructions)
Motor beeps 10 times when in use	Battery voltage is low / PV (solar panel issue)	Recharge with AC adapter or check connection and positioning of solar PV panel
Cannot program a single motor (multiple motors respond)	Multiple motors are paired to the same channel.	Always reserve an individual channel for programming functions
		SYSTEM BEST PRACTICE - Provide an extra 15 channel remote in your multi-motor projects that provides individual control for each motor for programming purposes
		Place all other motors into sleep mode (ref to P1 button instructions)



3DAYBLINDS®
YOU'LL LOVE THE TREATMENT

motorized[📶]
BY 3 DAY BLINDS

TDBU Roman Shade Programming Guide

Specifications



- 0.6Nm DC motor for Cellular/Honeycomb shades
- Approximately 500 up/down cycles per each full charge
- 3 motor speed settings; 34, 40 or 50rpm
- Sound level ~48dB
- 5 year warranty



P1 button (Programming button on motor)

Micro USB Charging Port

LED Light



Remote Button Instructions

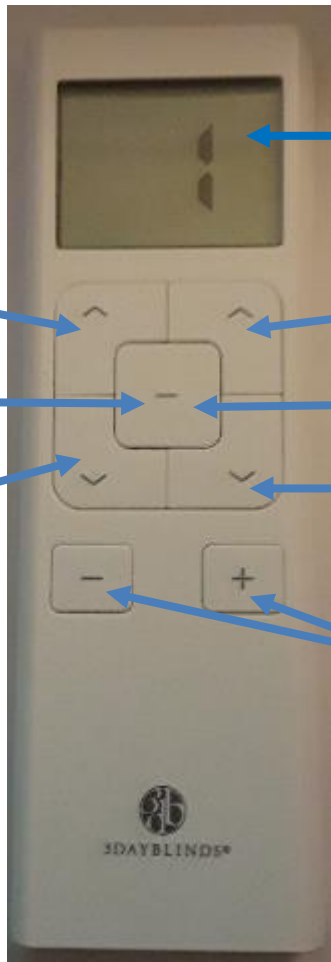

LCD Display (Channel you have selected, 0 operates all shades)

Bottom Rail Up

Mid Rail Up

Stop Bottom Rail

Stop Mid Rail

Bottom Rail Down

Mid Rail Down

Channel Select (15 Channel Remote, 0 is the all channel)

P2 Button (Remotes Program Button)



Small Blue Screw Driver – Used to secure back cover on remote. **Also can be used to press the P1 button. LEAVE W/CLIENT**

CR2450 Battery

Back cover

On / Off Switch (If shade does not respond to remote, check switch is On.)

P2 Button (Remotes Program Button)

Charging Instructions

- USB Charger with wall outlet, comes 10' or 16'

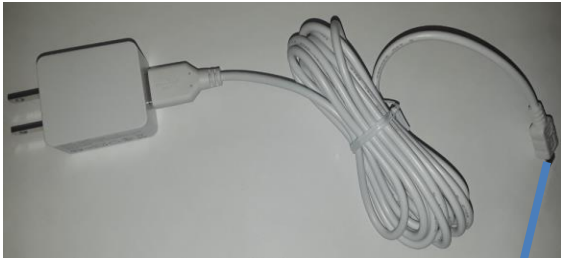











- Plug the charger into the wall and the micro USB tip into the shades charging port, similar to charging a cell phone.
- Charger can be left plugged in and will not harm the motor or battery. (They both have integrated overcharge protection circuits)
- Needs to be Charged about twice a year depending on usage.
- Production will charge the battery wand before sending it out to installer, it takes about 6 hours to fully charge.
- During operation, if the motor beeps 10 times, that is indicating a low battery and needs to be charged.
- During operation, if the battery is going low, it will stop running and will need to be charged.

Rechargeable Battery Status Indicator

- **Blinking Red** – Low Battery alert
- **Solid Red** - Charging
- **Blinking Green** – Charging in process
- **Solid Green** – Battery has finished charging

P1 Programming Button Instructions (P1 button located in front of the shade above micro USB charging port)

- 1. Test Motor:** (Test to make sure shade is charged & used to operate shade manually without remote)
 - Press P1 (Less than 1 sec) Until Shade Jogs   x1
 - Shade will wake up and start running down, press P1 to stop shade, P1 again to raise the shade.
- 2. Pairing Mode:** (Used to pair the shade to a remote)
 - Press P1 & Hold (Approx. 2 secs) Until shade Jogs   x1 then release.
 - When released the Motor will Beep x1, shade is ready to program to the remote
- 3. Sleep Mode:** (Used to program other shades on the same channel.)
 - Press P1 & Hold (Approx. 6 secs) Until Shade Jogs   x2
 - When released the Motor will Beep x2, press up or down on remote, shade should not move.
- 4. Reverse Direction:** (Used when shade goes up when you push down or down when you push up.)
 - Press P1 & Hold (Approx. 10 secs) Until Shade Jogs   x3
 - When released the Motor will Beep x3, press up or down on remote to check for proper direction is saved.
- 4. Reset To Factory Settings:** (Used to erase all previous programming and start with a clear motor.)
 - Press P1 & Hold (Approx. 10 secs) Until Shade Jogs   x4
 - When released the Motor will Beep x4 shade should not respond to remote, start from beginning with pairing the shade and setting the limits.

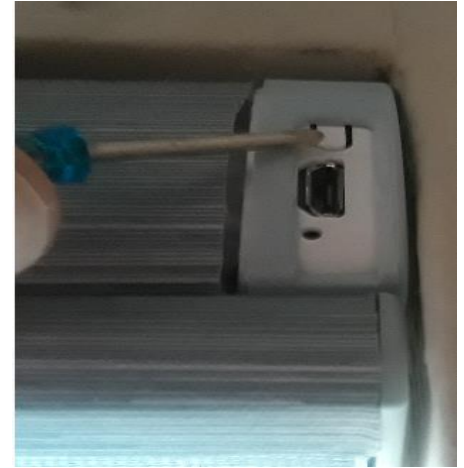

Pair / Unpair Remote Control To Shade

Step 1 : Press P1 button (about 2 sec) on the motor head until motor jog x1.

Step 2 : In the next 10 secs, press the + or – on the remote to select the channel you want the shade to be on, press and hold “Stop (-)” button until motor jog x2.

- Repeat the same procedure to unpair remote control and remove the shade from previous channel. Production has set the limits so shade should be ready to operate, see “Adjust Limits” to change the upper and lower limit.

Change Motor Direction (Only if Necessary)

Step 1 : Press Left “Up” or Left “Down” button to check if the shade moves in the desired direction.

- If you need to reverse the direction, press and hold (about 2 sec) Left “Up” and Left “Down” buttons simultaneously until motor jog x1.

***The operation is only valid when there are no limits. If the motor has already set the upper and lower limit, then you can only switch direction by pressing P1 button (See P1 button instructions).**

Setting the Upper & Lower Limits (These Steps are done if no limits are set from Factory, or you have Reset the motor to Factory Settings)

Step 1 : Set Upper Limit

- a. Press Right “Up” button to raise the Middle Rail, then press “Stop” button when it is in the desired upper limit.
- b. Press Left “Up” button to raise the Bottom Rail, then press “Stop” button when it is in the desired upper limit.
- c. Press and hold (about 5 sec) Left “Up” and “Stop” buttons simultaneously until motor jog x2.

Step 2 : Set Lower Limit

- a. Press Left “Down” button to lower the shade, then press “Stop” button when it is in the desired lower limit.
- b. Press Right “Down” button to lower the Middle Rail, then press “Stop” button when it is in the desired lower limit.
- c. Press and hold (about 5 sec) Left “Down” and “Stop” buttons simultaneously until motor jog x2.
 - If you exit the limit setting status before you finish the limit settings, the motor will take the previous existing limits.
 - After you are done setting the upper and lower limit the shade is ready to operate and is in user mode.
 - **You must set the Middle Rail and Bottom Rail Limits together or they will not save.**

Adjust the Upper & Lower Limits (These Steps are done when in user mode & If limits are set from factory)

Step 1 : Adjust the Upper Limit

- a. Press and hold (about 5 sec) Left “Up” and “Stop” buttons simultaneously until motor jog x1.
- b. Use Right “Up” button to raise the Middle Rail to the desired highest position, and use “Up” or “Down” button to do the final adjustment if necessary.
- c. Press Left “Up” button to raise the Bottom Rail, then press “Stop” button when it is in the new desired upper limit.
- d. Press and hold (about 5 sec) Left “Up” and “Stop” buttons simultaneously until motor jog x2.

Step 2 : Adjust the Lower Limit

- a. Press and hold (about 5 sec) Left “Down” and “Stop” buttons simultaneously until motor jog x1.
- b. Use Left “Down” button to lower the Bottom Rail then press “Stop” button when it is in the new desired lowest position, and use “Up” or “Down” button to do the final adjustment if necessary.
- c. Press Right “Down” button to lower the Middle Rail, then press Right “Stop” button when it is in the new desired lower limit.
- d. Press and hold (about 5 sec) Left “Down” and “Stop” buttons simultaneously until motor jog x2.

Favorite Position (By pressing & Hold “Stop” shade will go to this saved spot every time)

Action: Set Favorite Position

Step 1 : Use Left “Up” or Left “Down” button to move the shade to desired Favorite position.

Step 2 : Press and hold (about 2 sec) one “P2” button on the back of remote control until motor jog x1.

Step 3 : Press and hold (about 2 sec) “Stop” button until motor jog x1.

Step 4 : Once more, press and hold (about 2 sec) “Stop” button until motor jog x2.

Action : Send Shade to Favorite Position

Step 1 : Press and hold (about 2 sec) “Stop” button, motor will move to Favorite position.

Action : Delete Favorite Position

Step 1 : Press and hold (about 2 sec) one “P2” button on the back of the remote until motor jogs.

Step 2 : Press and hold (about 2 sec) “Stop” button until motor jog.

Step 3 : Once more, press and hold (about 2 sec) “Stop” button until motor jog x1.

Roller Mode & Sheer Mode (Sheer Mode is used to operate Roller shades in short increments and in Horizontal Sheer its used to open the slats in increments adjusting light control better)

Action: Roller Shade Mode - continue movement after a short press - Default Mode

Step 1 : Press and hold (about 5 sec) Left “Up” and Left “Down” buttons simultaneously until motor jog x1.

Step 2 : Press and hold (about 2 sec) “Stop” button until motor jog x2.

Action : Sheer Shade Mode - jog movement after a short press (continue movement after a long press)

Step 1 : Press and hold (about 5 sec) Left “Up” and Left “Down” buttons simultaneously until motor jog x1.

Step 2 : Press and hold (about 2 sec) “Stop” button until motor jog x1.

Add or Remove Additional Remote

Step 1 : On the current remote control, press and hold (about 2 sec) one “P2” button until motor jog x1.

Step 2 : Once more, on the current remote control, press and hold (about 2 sec) one “P2” button until motor jog x1.

Step 3 : On the New remote control, press and hold (about 2 sec) one “P2” button until motor jog x2.

* Repeat the same procedure to remove additional remote control.

Grouping Shades (Used to have a group of shades on one channel to operate simultaneously.)

Step 1 : On the remote Select the channel you want to add to a group. Turn remote over and remove battery cover.

Step 2 : Press and release (less than 1 sec) one of the “P2” buttons, shade will jog x1.

Step 3 : Press and release (less than 1 sec) one of the “P2” buttons again, shade will jog x1.

Step 4 : Turn the remote back over and select the channel you want to add the shade to (the group channel).

Step 5 : Turn remote over, Press and release (less than 1 sec) one of the “P2” buttons, shade will jog x2. Shade will now work on both original channel and the group channel.

* Repeat the same procedure to remove the shade from the group channel.

* You can also add the shade to a group channel by using the P1 button. Press the P1 button on the motor head(Approx. 2 sec) shade will jog x1. Then select the channel you want to add the shade to and press & hold the Stop button until the shade jog x2. Its now added to the group shades as well as its original channel. Repeat steps to erase shade from group.

Adjust Motor Speed (Used if all shades are running at different speeds, increasing the speed will shorten battery life.)

Action : Acceleration Speed

Step 1 : Press one “P2” button until motor jog x1.

Step 2 : Press Left “Up” button until motor jog x1.

Step 3 : Once more, press “Up” button until motor jog x2 and beep x1.

Action : Deceleration Speed

Step 1 : Press one “P2” button until motor jog x1.

Step 2 : Press Left “Down” button until motor jog x1.

Step 3 : Once more, press Left “Down” button until motor jog x2.

* If the motor has no response, it already has a Maximum or Minimum speed.

Advanced Setting (Disable Limit Setting so they are not changed by mistake)

Step 1 : Remove the cover from the backside of remote, the lock switch is in the right corner.

Step 2 : Move the switch to the “Lock” position to disable the following commands, remote will show “L” (lock):

- Change Motor Direction
- Setting the Upper and Lower Limit
- Adjust Limit
- Roller Mode or Sheer Mode

Step 3 : Move the switch to “Unlock” position to assess all remote functions, remote will show “U” (unlock).

* This advanced feature is intended to be used after all shade programming is completed. User Mode will prevent accidental or unintended changing of limits.

Quick Index

Settings	Steps
1 Pairing	P1 (hold down for 2s) > Stop (hold down for 2s)
2 Switch Rotating Direction	Left Up + Left Down (hold down for 2s)
3 Setting Upper & Lower Limits	Upper Limit: Up (hold down for 2s) > Left Up + Left Stop (hold down for 2s) Lower Limit: Down (hold down for 2s) > Left Down + Left Stop (hold down for 2s)
4 Add / Remove Favorite Position	P2 > Left Stop > Left Stop
5 Roller Mode & Sheer Mode Switch	Left Up + Left Down (hold down for 5s) > Stop
6 Adjust Limits	Upper Limit: Left Up + Left Stop (hold down for 5s) > Up or Down > Left Up + Left Stop (hold down for 2s) Lower Limit: Left Down + Left Stop (hold down for 5s) > Up or Down > Left Down + Left Stop (hold down for 2s)
7 Pair / Unpair Additional Emitter	P2 (existing) > P2 (existing) > P2 (new)
8 Speed Regulation	Acceleration: P2 > Left Up > Left Up Deceleration: P2 > Left Down > Left Down

Troubleshooting

Issues	Possible Causes	Solution
The motor has no response	External Battery Pack is depleted	Recharge with compatible AC adaptor and check connection and positioning of solar PV panel
	Insufficient charging from Solar PV Panel	Check connection and orientation of solar PV panel
	Remote control battery is discharged	Replace battery
	Battery is inserted incorrectly into remote control	Check battery polarity
	Radio interference / shielding	Ensure remote control and the antenna on the motor are positioned away from metal objects
	Receiver distance is too far from Remote Control	Move remote control to a closer position
	Power failure	Check power supply to motor is connected and active
Cannot program a single motor (multiple motors respond)	Incorrect wiring	Check that wiring is connected correctly (refer to motor installation instructions)
	Multiple motors are paired to the same channel.	Always reserve an individual channel for programming functions
		SYSTEM BEST PRACTICE - Provide an extra 15 channel remote in your multi-motor projects that provides individual control for each motor for programming purposes
		Place all other motors into sleep mode (Press "P1" button (about 6 sec) on the motor head until motor jog x2)



Motorization FAQs & Programing Videos:

<https://www.3dayblinds.com/motorization-faq>

 WARNING	
<ul style="list-style-type: none">• INGESTION HAZARD: This product contains a button cell or coin battery.• DEATH or serious injury can occur if ingested.• A swallowed button cell or coin cell battery can cause INTERNAL CHEMICAL BURNS in as little as 2 HOURS.• KEEP new and used batteries OUT OF REACH OF CHILDREN.• SEEK IMMEDIATE MEDICAL ATTENTION if a battery is suspected to be swallowed or inserted inside any part of the body.• CR 2032, 3v	 

- Remove and immediately recycle or dispose of use batteries according to local regulations and keep away from children.
- Do NOT dispose of batteries in household trash or incinerate.
- Even used batteries may cause severe injury or death.
- Call a local poison control center for treatment information.
- CR2032 is the compatible battery type.
- The nominal battery voltage is 3.0V.
- Non-rechargeable batteries are not to be recharged.
- Do not force discharge, recharge, disassemble, heat above 60° or incinerate. Doing so may result in injury due to venting, leakage or explosion resulting in chemical burns.
- Ensure the new batteries are installed correctly according to polarity (+ and -).
- Do not mix old and new batteries, different brands or types of batteries, such as alkaline, carbon-zinc, or rechargeable batteries.
- Remove and immediately recycle or dispose of batteries from equipment not used for an extended period of time according to local regulations.
- Always completely secure the battery compartment. If the battery compartment does not close securely, stop using the product, remove the batteries, and keep them away from children.